



FAI Sporting Code

*Fédération
Aéronautique
Internationale*

Section 4 - Aeromodelling

Volume F9 Drone Sport

2019 Edition

Effective 1st May 2019

DRONE RACING WORLD CUP RULES

F9A (Provisional class) - DRONE SOCCER RULES

F9U (Provisional class) - RC MULTI-ROTOR DRONE RACING RULES

*Maison du Sport International
Avenue de Rhodanie 54
CH-1007 Lausanne
Switzerland
Tel: +41(0)21/345.10.70
Fax: +41(0)21/345.10.77
Email: info@fai.org
Web: www.fai.org*

FEDERATION AERONAUTIQUE INTERNATIONALE
MSI - Avenue de Rhodanie 54 – CH-1007 Lausanne – Switzerland

Copyright 2019

All rights reserved. Copyright in this document is owned by the Fédération Aéronautique Internationale (FAI). Any person acting on behalf of the FAI or one of its Members is hereby authorised to copy, print, and distribute this document, subject to the following conditions:

- 1. The document may be used for information only and may not be exploited for commercial purposes.**
- 2. Any copy of this document or portion thereof must include this copyright notice.**
- 3. Regulations applicable to air law, air traffic and control in the respective countries are reserved in any event. They must be observed and, where applicable, take precedence over any sport regulations**

Note that any product, process or technology described in the document may be the subject of other Intellectual Property rights reserved by the Fédération Aéronautique Internationale or other entities and is not licensed hereunder.

RIGHTS TO FAI INTERNATIONAL SPORTING EVENTS

All international sporting events organized wholly or partly under the rules of the Fédération Aéronautique Internationale (FAI) Sporting Code¹ are termed *FAI International Sporting Events*². Under the FAI Statutes³, FAI owns and controls all rights relating to FAI International Sporting Events. FAI Members⁴ shall, within their national territories⁵, enforce FAI ownership of FAI International Sporting Events and require them to be registered in the FAI Sporting Calendar⁶.

An event organizer who wishes to exploit rights to any commercial activity at such events shall seek prior agreement with FAI. The rights owned by FAI which may, by agreement, be transferred to event organizers include, but are not limited to advertising at or for FAI events, use of the event name or logo for merchandising purposes and use of any sound, image, program and/or data, whether recorded electronically or otherwise or transmitted in real time. This includes specifically all rights to the use of any material, electronic or other, including software that forms part of any method or system for judging, scoring, performance evaluation or information utilised in any FAI International Sporting Event⁷.

Each FAI Air Sport Commission⁸ may negotiate agreements, with FAI Members or other entities authorized by the appropriate FAI Member, for the transfer of all or parts of the rights to any FAI International Sporting Event (except World Air Games events⁹) in the discipline¹⁰, for which it is responsible¹¹ or waive the rights. Any such agreement or waiver, after approval by the appropriate Air Sport Commission President, shall be signed by FAI Officers¹².

Any person or legal entity that accepts responsibility for organising an FAI Sporting Event, whether or not by written agreement, in doing so also accepts the proprietary rights of FAI as stated above. Where no transfer of rights has been agreed in writing, FAI shall retain all rights to the event. Regardless of any agreement or transfer of rights, FAI shall have, free of charge for its own archival and/or promotional use, full access to any sound and/or visual images of any FAI Sporting Event. The FAI also reserves the right to arrange at its own expense for any and all parts of any event to be recorded.

-
- 1 FAI Statutes, Chapter 1, para. 1.6
 - 2 FAI Sporting Code, Gen. Section, Chapter 4, para 4.1.2
 - 3 FAI Statutes, Chapter 1, para 1.8.1
 - 4 FAI Statutes, Chapter 2, para 2.1.1; 2.4.2; 2.5.2 and 2.7.2
 - 5 FAI By-Laws, Chapter 1, para 1.2.1
 - 6 FAI Statutes, Chapter 2, para 2.4.2.2.5
 - 7 FAI By-Laws, Chapter 1, paras 1.2.2 to 1.2.5
 - 8 FAI Statutes, Chapter 5, paras 5.1.1, 5.2, 5.2.3 and 5.2.3.3
 - 9 FAI Sporting Code, Gen. Section, Chapter 4, para 4.1.5
 - 10 FAI Sporting Code, Gen. Section, Chapter 2, para 2.2.
 - 11 FAI Statutes, Chapter 5, para 5.2.3.3.7
 - 12 FAI Statutes, Chapter 6, para 6.1.2.1.3

PAGE DELIBERATELY LEFT BLANK

VOLUME F9 DRONE SPORT

SECTION 4C - MODEL AIRCRAFT – F9 DRONE SPORT

A- Drone Racing World Cup rules

B- F9A (Provisional class) - Drone Soccer rules

C- F9U (Provisional class) - RC Multi-rotor Drone Racing rules

Annex C.1- Racing circuit

Annex C.2- Scenario A - 64 competitors selected from qualification stage

Annex C.3- Scenario B - 32 competitors selected from qualification stage

Annex C.4- Scenario C - 16 competitors selected from qualification stage

PAGE DELIBERATELY LEFT BLANK

THIS EDITION INCLUDES THE FOLLOWING AMENDMENTS MADE TO 15 MARCH 2018 EDITION

These amendments are marked by a double line in the right margin of this edition

Paragraph	Date of change	Brief description of change	Change incorporated by
Chapter B - F9A rules	Changes effective 1 st May 2019	Introduction of the F9A provisional class (Drone Soccer) rules (Chapter B). Consequently, chapter B has been renumbered C and Annexes 1 to 4 have been renumbered C.1 to C.4..	Bruno Delor S/C Chairman
Chapter A - Drone Racing World Cup rules	Changes effective 1 st January 2019	'Volume F3 Radio Control Drone Racing' renamed 'Volume F9 Drone Sport'. Class F3U renumbered F9U (name unchanged).	Bruno Delor S/C Chairman
Chapter B - F9U rules		Replacement of 'F3U' by 'F9U'. Replacement of 'contest' by 'event'. Adaptation of the World Cup rules to take in account the new World Cup format with Challenger and Masters World Cup Series. About requirement of competitors from at least two different countries for points allocation in a World Cup event, mention that every time zone will be considered as equivalent to a country for a country which extends over more than three time zones.	
B.1.1 Weight and size		Replacement of 'F3U' by 'F9U'. Mention that the necessary information must be available at least one month before the event (instead well before the event).	
B.1.2 Motorization		Clarification of the wording for the size specification.	
B.1.4 Radio Control (RC) equipment		Authorisation to use 6S batteries with increase to 25.5 volts of the maximum voltage of the battery.	
B.1.5 Video system		Mention that the organizer may define a list of authorized equipments and of the possible penalty in case of use of non-authorized RC equipment.	
B.1.6 LED light device (Optional)		Recommendation of a digital video recorder (DVR). Mention that the video system must be set with 25 mW maximum power emission. Mention of the possible penalty in case of non-authorized activation of a video transmitter.	
B.1.7 Identification marks		'Unit' replaced by 'device'. Mention of recommended specifications for the optional LED light device.	
B.2 Racing circuit		Removal of possibility to mention the National FAI Licence number instead the FAI ID number . Mention that the identification mark must be in a clearly visible position.	
B.3 Number of models		Rewording of the specifications.	
B.4 Model registration and processing		Clarification of the wording.	
B.6. Event organisation (Introduction part)		Clarification of the wording.	
B.6.1 Timekeeping		Recommendation of 4 pilots maximum per group, except for qualifying and/or optional additional rounds which may be run with 6 pilots per group.	
B.6.2 Procedure for the start of the race		Requirement of an electronic timing system (instead manual timekeeping) with an appropriate redundancy.	
B.6.3 Qualification stage		Clarification about the start procedure and the role of the starter.	
B.6.4 Elimination stage		Flexibility given to the organizer for the choice of the qualification method.	
B.6.6 Second Chance flight (Optional sequence)		Removal of the scenarios D and E with 6 pilots per group. Replacement of the double chance optional sequence by the double elimination optional sequence giving possibility to reach the final.	
B.6.6 Additional rounds optional sequence		Removal of this paragraph considering the new double elimination optional sequence is a part of the elimination stage (B.6.4). Consequently, sub-paragraph B.6.7 relative to additional rounds sequence is renumbered B.6.6.	
B.6.7 Final classification		Clarification of the additional rounds sequence modalities.	
B.7.1 Obstacle damaged or destroyed during the race		Mention in this new sub-paragraph of the cross-references to the final classification tables included in annexes 2 to 4.	
		Mention in this new sub-paragraph how to proceed when an obstacle is damaged or destroyed during the race.	

Paragraph	Date of change	Brief description of change	Change incorporated by
B.7.2 Faults and penalties	Changes effective 1 st January 2019	Removal of the time penalties possibility considering it may be introduced as a local rule when the indoor circuit justifies it.	Bruno Delor S/C Chairman
B.7.3 Disqualification from the race		Clarification of the wording.	
B.7.4 Crash		Mention that the pilot must clearly say when he stops to fly after a crash.	
B.7.5 Safety occurrence		Mention in this new sub-paragraph of possibility to request a pilot to the flight if it is considered the model no longer meets acceptable safety standards.	
B.8 Classification		Removal of this paragraph considering final classification information has been placed in sub-paragraph B.6.7.	
B.8 Reflights		Introduction of a new paragraph for reflights in order to better detail causes for reflights and organization of the reflights for the different stages of the event. Consequently, sub-paragraphs B.7.4 Video issues and B.7.5 Reflight have been included in this new paragraph. Clarification of the wording.	
B.9.1 Officials needed to run the event		Rewording of some parts of the sub-paragraph.	
B.9.3 Judges		Flexibility given to the organizer concerning position of the judges and clarification of their role.	
B.10 Interruption of the event		Clarification of the circumstances for which the event should be interrupted or the start delayed.	
Annex 1		Rewording of the recommendations regarding racing circuit.	
Annexes 2 to 4		Introduction of templates for each scenario (A, B and C).	

RECAPITULATION OF CHANGES INTRODUCED IN PREVIOUS EDITIONS

Paragraph	Date of change	Brief description of change	Change incorporated by
	Changes effective 15 March 2018	Clarification of the presentation of the document - Drone Racing World Cup rules presented in a chapter A (instead in Annex) and F3U rules in a chapter B, with consequent global renumbering of all paragraphs of the document.	Bruno Delor S/C Chairman
B (Introduction part)		Clarification of the presentation of the document - Introduction of the definition of a multi-rotor in that part (instead paragraph 1 'Model general specifications') and of the role of the helper (instead paragraph 7 'Helper').	
B.1 General specifications for models (Introduction part)		Introduction in that part of the document of the content of ex paragraph 1.4 'Other equipment'. Mention of the possibility to use software recovery modes.	
B.1.4 Radio-control equipment & B.1.5 Video system		Deletion of the ex paragraph 1.5 Splitting of the paragraph 1.6 'Frequencies' in 2 paragraphs (B.1.4 and B.1.5). Possibility for the organiser to: - authorise radio-control equipment other than 2,4 GHz (B.1.4); - limit video transmitters to a list of authorised devices (B.1.5); - define restrictions for use of radio-control equipments and video transmitters outside the racing circuit (B.1.4 and B.1.5).	
B.1.6 LED light unit (Optional device)		Clarification of the possibility for the organiser to require the competitors to equip models with a programmable LED light.	
B.1.7 Identification marks		Change from 10 mm to 6 mm for the minimum height of the letters and numbers.	
B.2 Racing circuit		Reference in annex B1 of the racing circuit design specifications and recommendations (ex paragraphs 2.2 to 2.6).	
B.3 Number of models		Mention that competitors who use the same model in a event will be disqualified from the event.	
B.4 Model registration and processing		Clarification of the specifications to be checked.	
B.5 Practice flights		Specific paragraph for the rules relative to practice flights (ex sub-paragraph 5.1).	
B.6 Event organisation (Introduction part)		In case of a lonummbor of w total number of competitors, introduction of the possibility to organise the event with one stage only with a fixed number of rounds for every competitor.	
B.6.1 Timekeeping		Recommendation to use an electronic timing system whenever possible instead manual timekeeping.	

Paragraph	Date of change	Brief description of change	Change incorporated by
B.6.2 Procedure for the start of the race	Changes effective 15 March 2018	Replacement of 'circle marshal' by 'starter'. Start procedure clarification.	Bruno Delor S/C Chairman
B.6.3 Qualification stage		New presentation of the qualifying stage organisation depending if timekeeping is electronic or manual with consequent deletion of previous options 1 to 3.	
B.6.4 Elimination stage		Removal of the scenario D and E (6 pilots per group). Replacement of the second chance optional sequence by a double elimination sequence.	
B.6.5 Final stage		Introduction of the selection modalities for the final when double elimination sequence is applied. Removal of the possibility to extend for the final number of laps to complete.	
B.6.6 Second chance flight (Optional sequence)		Introduction of the possibility to entitle a second chance to the pilots not selected for the next elimination round, instead their direct elimination. This sequence is not mandatory.	
B.6.7 Additional rounds (Optional sequence)		Introduction of the possibility to entitle additional rounds to the competitors who are not selected for the first elimination round. This sequence is not mandatory.	
B.7 Flight occurrences		Clarifications regarding treatment of some occurrences. Clarification of possibility of reflight after a flight collision.	
B.8 Classification		Introduction of a specific paragraph to detail classification modalities for each scenario A to E.	
B.9 Officials		Replacement of 'circle marshal' by 'starter'. Clarification of the sentence relative to the timekeeper. Clarification of the sentence relative to the judge's video device.	
Annex 1		Recommendation of a minimum of 4 air gates instead to request 3 to 5 gates. Change of some requirements in simple recommendations.	
Annexes 2 to 6		Introduction of an annex for draws for each scenario A to E.	
Volume title	Changes effective 15 March 2017	Change of the name of the Volume: Radio Control Drone Racing instead of Radio Control FPV Racing Model Aircraft.	Bruno Delor S/C Chairman
Page 7		For the rule freeze, deletion of the reference to the CIAM Organizing Committee for FAI International Events for Drones (IED).	
1		Change of the title of the paragraph. Introduction of the possibility for an organiser to require a LED light unit for better differentiation of the models in a race both for judges and for the public.	
1.2		Rewording of the fixed motor tilt rule.	
1.6		Clarification of the wording of the last sentence.	
2.1		Recommended developed size of racing circuit (instead of mandatory).	
2.4		Replacement dimensions 20 m and 10 m by respectively 10 m and 5 m on the drawing relative to a perfect trajectory.	
2.6		Clarification of the start positioning (start line or grid pattern).	
2.7		Choice given to the organiser to keep the circuit secret or to make it public before the event.	
4		New positioning of the paragraph 4.7 (Model registration and processing) with no rule change. Consequential renumbering of the following paragraphs.	
5.1		New positioning of the paragraph 4;8 (Practice flights) with no rule change.	
5.2		New paragraph to detail the race start procedure.	
5.3		New paragraph to detail timekeeping (manual and automatic).	
5.4		Following changes for the qualification stage (ex paragraph 4.1): - 3 qualifying rounds minimum (instead of 2) in order to give to competitors more chance to get a time. - Deletion of the note mentioning that time penalties is not appropriate in option 2. - Introduction of a new option (option 3).	

Paragraph	Date of change	Brief description of change	Change incorporated by
5.5	Changes effective 15 March 2017	Following changes for the elimination stage (ex paragraph 4.2): - Deletion of the note mentioning that time penalties is not appropriate in option 2. - Introduction of the option 3. - Adaptation of the composition of the groups for the first round (concerns options 1 and 2 only) plus other minor clarifications. The change of the order takes better in consideration placing after the qualifying stage; as an example, with the new table, the two best top pilots can only fly together in the final.	Bruno Delor S/C Chairman
5.6		Clarification of the final stage regarding introduction of the option, 3.	
6		New paragraph to cover all cases of flight occurrences.	
6.2		Identification in a unique paragraph of which is relative to disqualification of the race.	
6.3		Dedicated paragraph to mention how to proceed in case of crash of a model.	
6.5		Clarification of the paragraph (ex 4.6) relative to reflight.	
8.1		Introduction of the possibility of one timekeeper per pilot in addition to the judge. Two timekeepers per pilot in flight is necessary to minimize the risk of a timekeeping problem when timekeeping is not done by an automatic electronic device.	
8.2		Reference to Volume ABR changed to the corresponding reference to CIAM General Rules Volume.	
Annex		World Cup Rules	
World Cup name		Change of the name of the World cup: Drone Racing instead of FPV Racing.	
3		Clarification regarding the fact that CIAM Organising Committee for FAI IED does not exist more after FPV Racing S/C has been created.	
4		Alignment with the other World Cup with a minimum of 2 countries (instead of 3) for allocation of points in a World Cup event.	
7 and 8		Coordination of the World cup normally done by the FPV Racing and similar activities S/C Chairman with possibility of nomination of a dedicated World Cup coordinator.	
10.	Change effective 1st January 2017	Appropriate form of CIAM General Rules C.7.4 used for definition of World Cup Board.	Kevin Dodd Technical Secretary

RULE FREEZE FOR THIS VOLUME

Regarding the provisional statute of the F9A and F9U classes, the content of this Volume is not subject to Plenary Meeting approval, nor is it restricted by any rule freeze regulation.

It is under the direct control of CIAM Bureau and may be updated at any time during the year.

CONTENTS

A. DRONE RACING WORLD CUP RULES	13
A.1. CLASS.....	13
A.2. EVENTS.....	13
A.2.1. Challenger World Cup Series.....	13
A.2.2. Masters World Cup Series.....	13
A.3. PARTICIPANTS.....	13
A.4. POINTS ALLOCATION.....	13
A.5. CLASSIFICATION.....	14
A.6. AWARDS.....	14
A.7. ORGANISATION.....	14
A.8. COMMUNICATION.....	15
A.9. RESPONSIBILITIES OF THE EVENT ORGANIZER.....	15
A.10. WORLD CUP BOARD.....	15
B. F9A (PROVISIONAL CLASS) - DRONE SOCCER RULES	16
B.1. DRONE BALL GENERAL SPECIFICATIONS.....	16
B.1.1. Weight and size.....	16
B.1.2. Motorization.....	16
B.1.3. Propellers.....	17
B.1.4. Radio control (RC) equipment.....	17
B.1.5. LED light device.....	17
B.1.6. Scorer drone ball.....	17
B.2. PLAYING FIELD.....	17
B.2.1. Surface.....	17
B.2.2. Flying zone.....	17
B.2.3. Pilots' area.....	18
B.3. GOAL RINGS.....	18
B.3.1. Shape and dimensions.....	18
B.3.2. Position.....	18
B.3.3. Material and structure.....	19
B.3.4. Detection sensor.....	19
B.4. COMPOSITION OF A TEAM.....	19
B.4.1. Active players.....	19
B.4.2. Players' list.....	19
B.5. NUMBER OF DRONE BALLS.....	19
B.6. PRACTICE FLIGHTS.....	19
B.7. FORMAT OF THE EVENT.....	20
B.7.1. Format with group stage followed by knockout and final stages.....	20
B.7.2. Format with successive rounds.....	21
B.8. ORGANIZATION OF A MATCH.....	21
B.8.1. Position of the teams on the playing field.....	21
B.8.2. Start of a set.....	22
B.8.3. End of a set.....	22
B.8.4. Scoring.....	22
B.8.5. Safety occurrence.....	22
B.8.6. Set and match result.....	22
B.8.7. Video recorder.....	23
B.9. PENALTIES.....	23
B.9.1. Penalty shot.....	23
B.9.2. Warning.....	23
B.9.3. Yellow card.....	23

B.9.4. Red card.....	24
B.10. INTERRUPTION OF THE EVENT	24
B.11. DISQUALIFICATION.....	24
B.12. OFFICIALS.....	24
B.12.1. Event director	24
B.12.2. Referees	25
B.12.3. FAI Jury.....	26
C. F9U (PROVISIONAL CLASS) - RC MULTI-ROTOR DRONE RACING RULES.....	27
C.1. GENERAL SPECIFICATIONS FOR MODELS	27
C.1.1. Weight and size.....	27
C.1.2. Motorization.....	27
C.1.3. Propellers	28
C.1.4. Radio control (RC) equipment	28
C.1.5. Video system.....	28
C.1.6. LED light device (Optional)	28
C.1.7. Identification mark	29
C.2. RACING CIRCUIT	29
C.3. NUMBER OF MODELS.....	29
C.4. MODEL REGISTRATION AND PROCESSING.....	29
C.5. PRACTICE FLIGHTS	30
C.6. EVENT ORGANISATION.....	30
C.6.1. Timekeeping.....	30
C.6.2. Procedure for the start of the race	30
C.6.3. Qualification stage	31
C.6.4. Elimination stage.....	32
C.6.5. Final stage.....	32
C.6.6. Additional rounds optional sequence	33
C.6.7. Final classification	34
C.7. FLIGHT OCCURRENCES	34
C.7.1. Obstacle damaged or destroyed during the race.....	34
C.7.2. Faults and penalties	34
C.7.3. Disqualification from the race.....	34
C.7.4. Crash.....	34
C.7.5. Safety occurrence	35
C.8. REFLIGHTS	35
C.8.1. Causes for reflight	35
C.8.2. Organization of the reflights	35
C.9. OFFICIALS.....	35
C.9.1. Officials needed to run the event	35
C.9.2. FAI Jury.....	36
C.9.3. Judges.....	36
C.10. INTERRUPTION OF THE EVENT	36
C.11. COMPETITORS INFORMATION.....	36
ANNEX C.1- RACING CIRCUIT.....	27
ANNEX C.2- SCENARIO A - 64 competitors selected from qualification stage	29
ANNEX C.3- SCENARIO B - 32 competitors selected from qualification stage	32
ANNEX C.4- SCENARIO C - 16 competitors selected from qualification stage	35

The use of “shall” and “must” implies that the aspect concerned is mandatory. The use of “should” implies a non-mandatory recommendation; “may” indicates what is permitted, and “will” indicates what is going to happen. Words of masculine gender shall be taken as including the feminine gender unless the context indicates otherwise. Words expressing the singular will be taken to include the plural and vice versa. Italics are used for explanatory notes.

A. DRONE RACING WORLD CUP RULES

A.1. CLASS

The FAI provisional class F9U (Multi-rotor Drone Racing) is recognised for the Drone Racing World Cup.

A.2. EVENTS

The Drone Racing World Cup is based on two series of events: Challenger and Masters.

All Drone Racing World Cup events will be considered as Second Category events as defined in FAI Sporting Code General Section.

Those events will be published on the FAI Calendar and must be run according to the FAI Sporting Code.

A.2.1. Challenger World Cup Series

Only Open International events may be considered for the Challenger World Cup Series.

The selection of the events for the Challenger World Cup Series is done by the Drone Sport Subcommittee Chairman. Wherever possible, the selection for a particular year will be done before the end of the preceding year. In duly justified cases, an event can be added after this date at the discretion of the Drone Sport Subcommittee Chairman.

A maximum of two events may be selected for any country on its own behalf unless the country extends over more than three time zones; in that case, one event may be selected within each time zone of the country with a maximum of four events for the country on its own behalf.

A country may choose to run a Challenger World Cup event at a venue in another country provided that the registration of the event on the FAI calendar is submitted by the organising country and the name of the organising country is included in the title of the event. Any country may host one event maximum on behalf of another organising country regardless of whether or not the host country extends over more than three time zones.

A.2.2. Masters World Cup Series

The selection of the events for the Masters World Cup Series will be done by a specific group whose composition will be defined by the FAI Executive Board.

Wherever possible, the selection for a particular year as Masters World Cup event will be done before the end of the preceding year.

A.3. PARTICIPANTS

Any person holding a valid FAI Sporting Licence or FAI Drone Permission may participate in a Challenger World Cup event and so be eligible for the World Cup ranking.

Participation in the Masters World Cup events is limited to the qualified competitors considering the current World Cup ranking. The current World Cup ranking will be based on a sliding 12 months period.

A.4. POINTS ALLOCATION

In any event, points for the World Cup will only be allocated if the competitors have flown from at least two different countries. For a country which extends over more than three time zones, every time zone will be considered as equivalent to a country.

Points allocated to each competitor depend of the placing in the event of the concerned competitor.

In the situation of a tie for any placing, the competitors with that placing will share the points which would have been awarded to the places covered had the tie been resolved (round up the score to the nearest whole number of points).

The points allocated to competitors will depend on the number (N) of competitors who have effectively flown in the event.

Points are allocated as follows to the competitors who have effectively flown in the event.

a) N > 40

Placing	1	2	3	4	5	6	40 and after
Points	40	39	38	37	36	35	1

b) N = 40 or N < 40

Placing	1	2	3	4	5	6	N-1	N
Points	N	N-1	N-2	N-3	N-4	N-5	2	1

In addition, bonus in points will be awarded for the best placed competitors.

For any Challenger World Cup event, bonus in points is awarded to the three best placed competitors as follows:

- 1st place = $N/5$ rounded up to the nearest whole number with a maximum of 8 points.
- 2nd place = $N/8$ rounded up to the nearest whole number with a maximum of 5 points.
- 3rd place = $N/13$ rounded up to the nearest whole number with a maximum of 3 points.

For a Masters World Cup event, bonus in points is awarded to the eight best placed competitors as follows:

- 1st place = $N/2,5$ rounded up to the nearest whole number with a maximum of 16 points.
- 2nd place = $N/3$ rounded up to the nearest whole number with a maximum of 14 points.
- 3rd place = $N/3,5$ rounded up to the nearest whole number with a maximum of 12 points.
- 4th place = $N/4$ rounded up to the nearest whole number with a maximum of 10 points.
- 5th place = $N/5$ rounded up to the nearest whole number with a maximum of 8 points.
- 6th place = $N/7$ rounded up to the nearest whole number with a maximum of 6 points.
- 7th place = $N/10$ rounded up to the nearest whole number with a maximum of 4 points.
- 8th place = $N/20$ rounded up to the nearest whole number with a maximum of 2 points.

A.5. CLASSIFICATION

The World Cup results are determined by considering the points obtained by each competitor in the World Cup events.

For each competitor, only one World Cup event result per organising country may be considered for the World Cup placing (better number of points for any organising country in which the competitor has scored in two events). For a country which extends over more than three time zones, one event may be counted for this organising country within each time zone of the country.

The total World Cup score of the competitor is the sum of his(her) best four event results (numbers of points) for all World Cup events (Challenger and Masters).

The winner of the World Cup is the competitor with the greatest total score for the concerned year, and so on for the placing.

In the situation of a tie for first, second or third place, placing will be determined by taking in account for the competitors in question, their best fifth result, then if necessary, their sixth best result, and so on. If this does not separate the tied competitors, then the placing will be determined by considering for their best four results the points that they obtained in each of those four events multiplied by the number of competitors who will have completed at least one flight in the event; the winner is the one with the greatest total thus calculated.

A.6. AWARDS

The winner is awarded the title of World Cup winner for the concerned calendar year.

Medals, trophies, prizes, or certificates may also be awarded as available.

A.7. ORGANISATION

Administration, collection of the results, calculation of the placing and regular publication of the current World Cup positions are normally done by the Drone Sport Subcommittee Chairman.

A dedicated World Cup Coordinator may be nominated. Such a nomination is done by the CIAM

Bureau on proposition of the Drone Sport Subcommittee Chairman.

A.8. COMMUNICATION

The World Cup results and placing could be distributed to the news agencies and also be available, by payment of a subscription, to any interested bodies or individuals.

Final results of the World Cup must be sent also to the CIAM with the annual report to be done by the World Cup Coordinator.

A.9. RESPONSIBILITIES OF THE EVENT ORGANIZER

The event organizers must propose their event for inclusion in the World Cup on the CIAM form for registration on the FAI Aeromodelling Sporting Calendar.

The selection of the events eligible for inclusion in the World Cup will be done from those proposals as specified in paragraph 3.

Immediately after the event, the organizer must send the results in electronic form to the World Cup coordinator, at least within one month as required by the CIAM rules. Any failure to return results promptly will be reviewed when considering the events for inclusion in the World Cup for the following year.

A.10. WORLD CUP BOARD

A Board of three persons shall be nominated by the Drone Sport Subcommittee Chairman to rule on any issue concerning the implementation of World Cup rules during a year. Any such issue must be submitted in writing to the Subcommittee Chairman. The World Cup Board is not entitled to deal with any kind of complaint or protest concerning a single event, which must be considered by the FAI Jury for that event.

B. F9A (PROVISIONAL CLASS) - DRONE SOCCER RULES

Drone soccer is a mix between drone flying and soccer done.

A drone soccer match opposed two teams with a defined number of players flying each a drone ball over the flying zone. The match is subdivided in three periods of time, each of them being considered as a set.

The team is composed of a "striker" who is the only one who may score with its drone ball going through the opponents' goal ring. The other team's players may act as guide or defender.

B.1. DRONE BALL GENERAL SPECIFICATIONS

A 1 % tolerance is applicable for inaccuracy of the measurement devices for size, weight and pack of battery voltage.

The drone ball must be equipped with a fail-safe device, the triggering of which stops the motors.

The following are strictly forbidden:

- Pre-programmed manoeuvring device.
- System for automatic positioning and/or path rectification in longitude, latitude or height.

Note: *Software recovery modes such as 'anti Turtle' or 'anti crash' and automatic system or which can be activated by the pilot in order to level back the drone ball after a crash are permitted.*

The drone balls may be checked by the organizer before the event begins.

B.1.1. Weight and size

The total weight of the drone ball including all equipment necessary for flight (including outer frame and batteries) shall not exceed 1 kg.

A spherical outer protective frame shall surround the drone ball. The diameter of the frame must be 40 cm \pm 2 cm.

All the components of the drone ball must be inside the spherical protective frame. Nothing must be placed outside this frame.

The frame may be truncated 2 cm maximum on its base for stability of the drone ball on the ground.

Any individual open surface of the frame must be 150 cm² maximum.

Note: This requirement is to prevent drone balls with a too light protective framework surrounding the drone ball. Although a lighter drone ball can offer better flying performance, too protective frames can adversely affect the game due to frequent interference and damage.

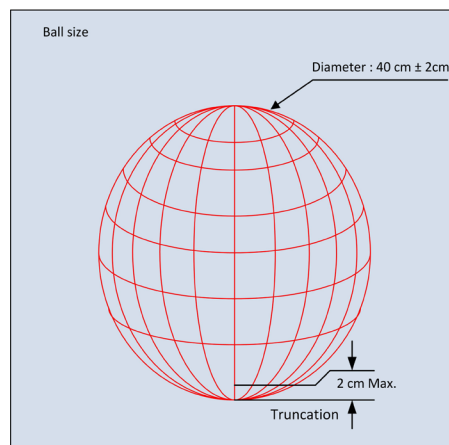

B.1.2. Motorization

Only electric motors are allowed.

The drone ball may be equipped with a maximum of four electric motors.

The maximum voltage of the pack of batteries must not exceed 17.0 volts (4S). The voltage measurement will be done before the beginning of the match.

B.1.3. Propellers

Maximum diameter: 6 inches (15.2 cm).

Full metal propellers are forbidden.

B.1.4. Radio control (RC) equipment

Every 2.4 GHz spread spectrum technology RC equipment may be used.

In order to limit risk of potential problems with unwanted interference during a match, the event director may define restrictions for use of RC systems equipment outside the playing field.

In case of a non-authorized use of a RC equipment, penalty going up to disqualification of the concerned team (see B.11).

B.1.5. LED light device

In order that during a match, drone balls of each team could be clearly identified, each drone ball must be equipped with an LED light device that has the capability to choose from a set of different colours.

The organizer must define the specifications of the LED light device or a list of authorized devices.

Recommended specifications:

- 40 to 60 LEDs fixed on the spherical framework which surrounds the drone ball so that the drone ball can be seen clearly from any direction.
- Colours: Blue - Green - Red - Yellow
- RGB controller to program the assigned colour for the match.

B.1.6. Scorer drone ball

The drone ball of the striker (scorer drone ball) must be easily recognizable from any point on the playing field, compared to the other drone balls of the team, or of the opponent's team.

It may be obtained with a different or additional LED light device different, or with a specific tag. The organizer may define the corresponding specifications.

B.2. PLAYING FIELD

Drone soccer event may be run indoor or outdoor.

The playing field is mainly composed of a flying zone and two pilots' areas (one for each team).

B.2.1. Surface

There are no precise specifications regarding the surface of an outdoor playing field or the floor of an indoor arena or gymnasium.

Surface of an outdoor playing field must be sufficiently flat. In addition, too hard surface covering or floor, such as asphalt or concrete, should be avoided for the flying zone in order to minimize risk to damage the drone ball when it falls on the ground.

In case the surface of the flying zone is covered with a soft artificial material, the organizer will take care a drone ball cannot sink in the covering material more than about one centimetre in order to avoid take-off problem. The organizer will also check that 'spring effect' will be limited.

B.2.2. Flying zone

The flying zone shall be a rectangle marked by lines. The dimensions of the rectangle will be fourteen to twenty meters for the longer side, and seven to ten meters for the shorter one. In any case, the length of the flying zone will be twice the width.

A centre line will be marked at the middle of the longer side of the flying zone. The centre of the flying zone (middle of the centre line) will be also marked.

There shall be no obstacle(s) on the flying zone or closed to it which may hinder the game.

Note: For indoor, height without obstacle(s) over the surface of the flying zone shall be five meters minimum in order to allow drone balls to go above the goal rings.

Two areas for start and take-off of the drone balls (one for each team) will be marked inside the flying zone. The start area will be positioned in the middle part of the baseline (shorter side of the flying zone). Length of the start area will be about half the baseline width and depth will be about (but not less) 1.5 m. Position and dimensions of the two start areas will be identical.

All marks on the ground will be clearly visible using a colour distinguishable from the ground surface colour.

B.2.3. Pilots' area

The pilots' areas (one for each team) will be placed outside the flying zone on the shorter sides as defined on the following scheme. Position and dimensions of the two pilots' area will be identical.

Each pilots' area will be marked.

During the sets of a match, only the players who are effectively flying (active players) may be in the pilots' area. The other members of the team (reserve players and coaches) must be outside the flying zone and the pilots' areas.

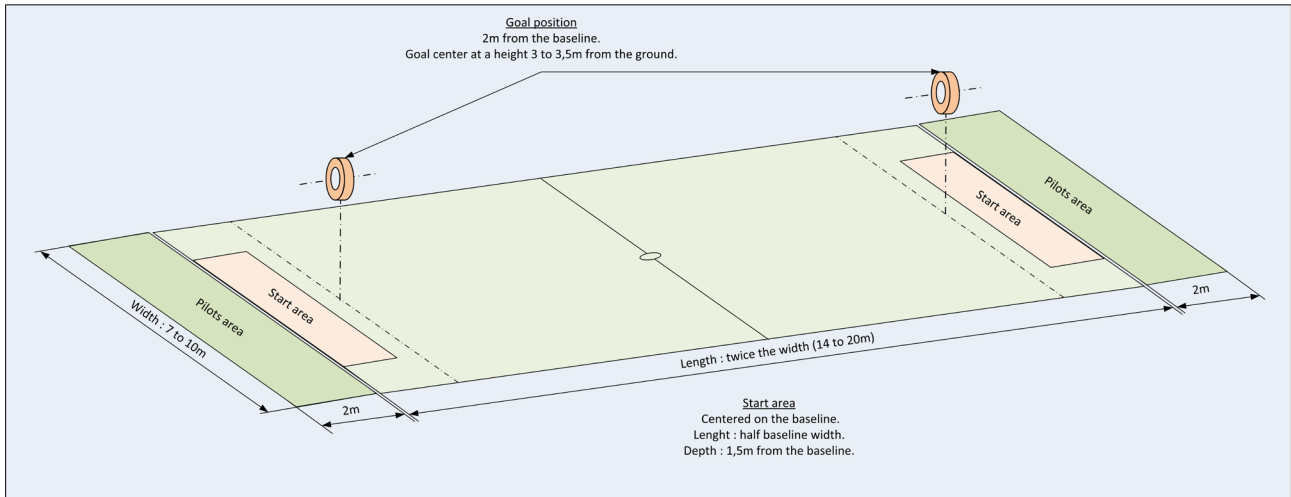

B.3. GOAL RINGS

The flying zone will be equipped with two goal rings (one for each team).

B.3.1. Shape and dimensions

The goal ring will be circular, with an internal diameter of 60 to 80 cm and an external diameter of 100 to 120 cm.

The thickness of the goal ring will be 20 cm minimum.

The two goal rings will be identical.

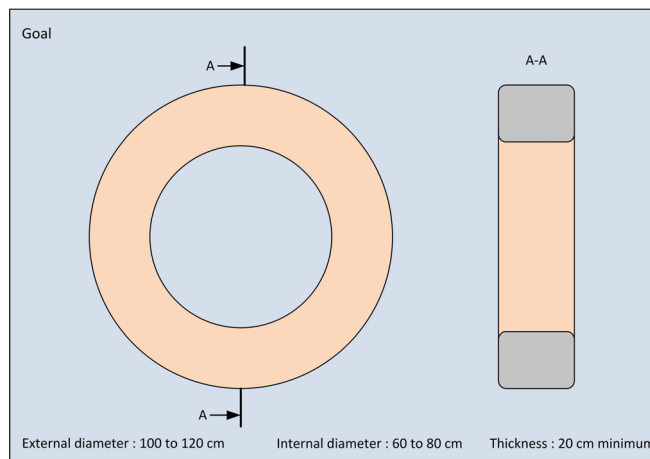

B.3.2. Position

Each goal will be positioned at about 2 m inside the baseline (shorter sides of the flying zone) at a height from the ground of 3 to 3.5 m measured from the centre of the goal ring).

The goal rings must face the centre of the flying zone. They will be fixed on posts or suspended from the ceiling taking care they cannot fall down and to avoid any swaying. It is important to ensure a firm, stable and secure fixation of the goal rings and to avoid any possibility of swaying of the goal rings.

Position of the two goal rings will be identical.

B.3.3. Material and structure

The material must be strong enough to minimize risk of a damage or deformation which may affect the game, but sufficiently flexible to avoid damages on the drone balls.

The goal ring must be visible and easily identifiable from any position around the playing field. The goal ring shall have a distinguishable colour for easy identification. It is also possible to add lighting systems on the goal rings to increase its visibility.

B.3.4. Detection sensor

For automatic scoring, a detection sensor may be installed on each goal ring subject it does not affect possibility for the drone ball to go through the goal ring. The sensor shall be installed so that he will be actuated only when the centre of the drone ball passes through the front face of the goal ring.

Note: *In case of an automatic scoring is used, teams shall be informed about position of the detection sensors before the match begins.*

B.4. COMPOSITION OF A TEAM

The team consists of players and coaches. Unless specified differently for the event, a coach may participate as a player.

B.4.1. Active players

Drone soccer is played with a maximum of 5 active players. The organizer must precise the authorized number of active players (5, 4, 3 or 2) when announcement of the event is done. Except exceptional circumstances, this number cannot be changed during the event. In case the event is organized with different rounds, the main referee may decide (after a round is completed) to reduce the number of active players subject a majority of the teams still participating in the event agree the decision.

The organizer will also define the total number of persons authorized for a team. In any case, a maximum of 10 (ten) persons may be authorized; this maximum number must be adapted depending the authorized number of active players. The organizer may also precise a maximum number of players and/or the number of authorized dedicated coaches.

The active players include one striker (scorer). The other active players can play as guide or defender. Any active player may only control one drone ball. So, the number of drone balls in flight cannot be higher than the number of active players.

Replacement of an active player is only possible during a break between two sets and can only be considered with players mentioned on the players' list for the concerned team.

One of the active players will be appointed as the team captain. He will be the point of contact for the match referee on the playing field.

B.4.2. Players' list

The players' list for each team must be submitted before the beginning of the event as required by the organizer, and in any case no later than 30 minutes before the first match.

The players' list will also mention the dedicated coach(es) in order to check it complies with the total number of persons authorized for a team for the event.

The list may not be changed as soon as the event begins.

Note: *Mention of the strikers and team captains on the players' list will not be requested considering they may change between two sets and for the different matches.*

B.5. NUMBER OF DRONE BALLS

Each active player may have 2 (two) drone balls ready for a match. The spare drone ball cannot be equipped with a pack of batteries when it is not used for flight.

The player may only change the drone ball or the pack of batteries during the break between two sets.

B.6. PRACTICE FLIGHTS

Practice sessions may be organized. The event director has the responsibility to define the conditions of the practice sessions.

Flights other than those authorized by the organizer are strictly forbidden under threat for the team to be disqualified from the event.

B.7. FORMAT OF THE EVENT

The organizer defines the event format. The format must be announced as soon as possible and at least one month before the event.

There are two main types of formats which may be considered:

- Group stage followed by knockout and final stages.
- Successive rounds.

Note: *The event may be a single match, a competition or contest, a tournament, etc.*

B.7.1. Format with group stage followed by knockout and final stages

This format is based on the Football World Cup format.

The event begins with a group stage followed by a knockout stage (round of 16, and/or quarter-finals, semi-finals), and then by the final stage with the play-off for the third place and the final.

In the group stage, every team play a match against each other team of the group. For each group, it could be considered 3 to 5 teams taking care of a close number of teams for all groups.

The groups are defined with a random draw.

B.7.1.1 Group stage ranking

For each match, points will be awarded as follows:

- 3 points for a win.
- 1 point for each team for a draw.
- 0 point for a defeat.

In each group, the two best placed teams will be selected for the first knockout stage round.

The ranking of each team in their group will be determined with the following criteria:

- a) Greatest number of points obtained in all matches of the group.
- b) Goals difference in all matches of the group.
- c) Greatest number of goals scored in all matches of the group.

If, on the basis of the above criteria, there is still a tie for the first or the second place in the group, a penalty shootout will be organized to break the tie between the concerned teams.

B.7.1.2 Knockout stage

The knockout stages are done with direct elimination of the teams which have lost their match.

B.7.1.3 Scenarios for illustration

See below two examples of scenarios, one corresponding to a scenario for 24 teams and the other to a scenario for 16 teams.

a) Scenario for 24 teams

- Group stage: 8 groups (A to H) with 3 teams in each group. Each team plays 2 matches which means 3 matches for each group and so a total of 24 matches for the group stage.
- First knockout stage round (round of 16) - 8 matches (16 teams)
 - . Winner A & Runner-up B = 1
 - . Winner B & Runner-up A = 2
 - . Winner C & Runner-up D = 3
 - . Winner D & Runner-up C = 4
 - . Winner E & Runner-up F = 5
 - . Winner F & Runner-up E = 6
 - . Winner G and Runner-up H = 7
 - . Winner H and Runner-up G = 8
- Second knockout stage round (quarter-finals) - 4 matches (8 teams)
 - . Winner 1 & Winner 3 = A
 - . Winner 2 & Winner 4 = B
 - . Winner 5 & Winner 7 = C
 - . Winner 6 & Winner 8 = D

- Third knockout stage round (semi-finals) - 2 matches (4 teams)
 - . Winner A & Winner C
 - . Winner B & Winner D
- Play-off for third place - 2 teams & 1 match: Semi-finals losers.
- Final - 2 teams & 1 match: Semi-finals winners.

40 matches in total: 24 for the group stage, 14 for knockout stage and 2 for the final stage.

b) Scenario for 16 teams

- Group stage: 4 groups (A to D) with 4 teams in each group. Each team plays 3 matches which means 6 matches for each group and so a total of 24 matches for the group stage.
 - First knockout stage (quarter-finals) - 4 matches (8 teams)
 - . Winner A & Runner-up B = 1
 - . Winner B & Runner-up A = 2
 - . Winner C & Runner-up D = 3
 - . Winner D & Runner-up C = 4
 - Second knockout stage (semi-finals) - 2 matches (4 teams)
 - . Winner 1 & Winner 3
 - . Winner 2 & Winner 4
 - Play-off for third place - 2 teams & 1 match: Losers of the semi-finals.
 - Final - 2 teams & 1 match: Winners of the semi-finals.
- 32 matches in total: 24 for the group stage, 6 for knockout stage and 2 for the final stage.

B.7.2. Format with successive rounds

This format may be run with direct elimination, or with double elimination.

Note: *In such a format, a lower total of matches is played compared to the other format, which means less time necessary to run the event for a given total number of teams.*

A random draw will be done for each round. When it is possible, it is recommended to avoid a same pair of teams in two different rounds.

In a situation of an odd number of teams in a round, the last team which has been drawn will not play in the round. This team will play twice in the following round:

- in the first match;
- and then in the last match if the number of teams permits it and if the team is not eliminated after the first match.

For each match, the winning team is selected for the next round.

For the direct elimination option, each team losing its match in the first round is eliminated, and so on for the following rounds.

For the double elimination option, a team will be eliminated after losing two matches.

B.8. ORGANIZATION OF A MATCH

A match is subdivided in three sets. Period of time for each set will be 3 (three) minutes.

Except an exceptional circumstance, the break between two sets will be limited to about two to three minutes which is normally sufficient to get back the drone balls and place them on the start areas.

Note: *It is recommended to provide a LED display or equivalent to show the remaining playing time. This will be useful for the teams, the officials and the audience.*

B.8.1. Position of the teams on the playing field

The match referee does a coin toss in order to determine position of the teams on the playing field (left or right side).

The team which wins the coin toss chooses its side, which defines the pilots' area. The teams keep the same side for all the match, and so stay on the same pilots' area for the three sets. Nevertheless, if the match referee considers that a circumstance, such as wind for an outdoor match, may affect the result of the match, he may decide differently. A team cannot complain or protest against such a decision, and cannot request a side change between two sets.

After the allocation of the pilots' areas is decided, the captain of each team may check the goal ring in which the team must score.

B.8.2. Start of a set

The start of each set will be done as follows:

- After the drone balls have been placed on the start areas, the match referee will request the two team captains if their team are ready to start.
- When the match referee considers that the teams are ready, he will announce clearly 'Arm your quads'.
- About 3 to 5 seconds after this announcement, a brief and intelligible sound signal will be done for the start of the set.

The match referee must stop the game and request a new start when he considers that:

- the start procedure has not been done properly;
- a player starts before the signal and doing so may give an advantage to the team.

In case of early start, a penalty shot may be granted against the concerned team (see B.9.1).

B.8.3. End of a set

The match referee is responsible to define the end of the set.

He will take to consider when necessary additional time taking in account that time consumed for a penalty shot must not be considered as a part of the period of time of the set (see B.9.1).

The announcement of the end of the set will be done with a brief and intelligible sound signal.

B.8.4. Scoring

A team scores a goal when the scorer drone ball (striker player) passes through the goal ring of the opponents' team subject:

- the goal ring has been crossed in the direction of the opponents' baseline,
- and half of the drone ball has passed through the front side of the goal ring.

The match referee is responsible to decide if the goal may be scored even if an automatic scoring system is used.

Scoring by passing through the opponent's goal ring with the drone ball of an active player who is not the striker will not be recognized as a score. There will be no penalty for that.

When a team scores a goal, all active players of the concerned team must immediately return on their side beyond the centre line before attempting a new score. A drone ball which falls on the ground is not concerned by this requirement if the drone ball is no more in situation to take-off again. It is not forbidden for the opponents' team to do blocking to prevent the drone balls to return on their side.

In case of a violation of this rule, a penalty shot may be granted against the concerned team (see B.9.1). In any case, a score which will be considered by the match referee as resulting from a violation of this rule will not be validated.

Note: *In case of a temporarily loss of control on a drone ball, the concerned player must do the best to return on its side after recovering the control. If the player considers that the loss of control is definitive, he must actuate the fail-safe and notify the match referee (or where appropriate the assistant referee) as soon as the drone ball is on the ground. Then, the player must leave the pilots' area.*

The striker may pass or remain in its own goal ring for defence purpose. Another active player of the team may pass through its own goal ring when it is not done with the intention to block the opponents' team. When a player, other than the striker, passes or stays inside its own goal ring for defence purpose, a penalty shot is granted against the concerned team (see B.9.1).

B.8.5. Safety occurrence

An active player can be requested by the match referee (or an assistant referee) to stop to fly if it is considered the drone ball no longer meets acceptable safety standards. It could be for example the case when the drone ball is damaged after a collision or after a crash, or when the pack of batteries is dangling.

B.8.6. Set and match result

For each set, the team that scores more goals in the set wins the set. If both teams score the same number of goals, or neither team scores a goal, the set ended in a draw.

The team that wins the best of three sets wins the match.

If both teams win the same number of sets in the match, the match is a draw. The main referee defines how to proceed when it is necessary to decide between the two teams (for example for an event with direct elimination rounds): coin toss, time overtime period, penalty shootout, This must be clearly announced before the beginning of the event.

Overtime period: It will be run same way as a standard set except the first goal determines the winning team (Sudden death / Golden goal).

Penalty shootout: It will be played same way as the penalty shot (see B.9.1). A minimum number of penalty shots (for example 5) is defined. Whenever possible, penalty shots must be done by different players of the team. All teams will be informed of the penalty shootout procedure which will applied before beginning of the event.

In case a team withdraws for a match (or for the rest of event), the concerned match(es) will be considered as lost by the team. The same applies or is disqualified from the event.

If a match is definitively stopped before its end, the current result based on the number of sets won determines the winner of the match except when the match is stopped because a team get a red card (see B.9.4). If both teams are equal and when it is necessary to decide between the two teams (for example for an event with direct elimination rounds), the match referee organizes a coin toss to determine the winner.

If the event cannot go on to the end, the last available provisional ranking will be considered for the final ranking.

B.8.7. Video recorder

In case a video recorder to monitor the match is installed, this "official" video record cannot be used by the match referee to make decisions or to review a decision during the match.

It may only be used by the concerned official(s) to manage a complaint or protest.

B.9. PENALTIES

All penalties (penalty shot, warning, yellow and red card) are granted by the match referee.

Penalties are no more valid as soon as the match is finished.

B.9.1. Penalty shot

A penalty shot may be granted against a team in the following situations:

- Start of a drone ball before the start signal (see B.8.2).
- When the player(s) do not return properly on their side after their team has scored a goal (see B.8.4).
- When an active player other than the striker passes or stays inside its own goal ring for defence purpose (see B.8.4).

The time consumed for the penalty shot will not be considered as a part of the period of time of the set.

B.9.2. Warning

A warning may be given to a team in the following situations:

- Non authorized person (reserve player, coach, ...) in the pilots' area during a set.
- Minor uncivilized conduct of a player or a coach towards a referee, an opponent player or coach, or a spectator.
- Delay of the start of the match or of a set caused by a team without acceptance of the match referee.
- Simple movement of a drone ball before the signal ball which will not be considered as an early start.
- Non intentional contact during a set of a drone ball on a person.

B.9.3. Yellow card

When two warnings are given for the same reason during a match to a team, a yellow card is given to the team.

In addition, a yellow card may be directly given to a team in the following situations:

- Change of an active player during a set.

- Major uncivilized conduct of a player or a coach towards a referee, an opponent player or coach, or a spectator.
- Intentional manipulation of a drone ball during a set.
- Intentional contact during a set of a drone ball on a person.

When a yellow card is given, the set is stopped and considered lost for the concerned team.

B.9.4. Red card

When two yellow cards are given during a match to a team, a yellow card is given to the team.

In addition, a red card may be directly given to a team in the following situations:

- Active player not registered on the players' list.
- Severe uncivilized conduct of a player or a coach towards a referee, an opponent player or coach, or a spectator.
- Dangerous or hazardous behaviour or action of an active player during a set.

When a red card is given, the match is stopped and considered lost for the concerned team.

B.10. INTERRUPTION OF THE EVENT

The event should be interrupted or the start delayed in the following circumstances:

- For an outdoor event, due to atmospheric conditions (rain, stormy condition, ...) in which it would be dangerous to continue to fly, or if wind is continuously stronger than 9 m/s measured at 2 m above the ground near in the centre of the playing zone for at least one (1) minute.
- Any incident affecting safety or requiring access for emergency services

The decision is taken by the main referee in conjunction with the event director.

The match referee has the right to interrupt a set for an external disturbance or any other justified reason. When an interruption occurs during a set, the set must be completely rerun when possible except if the match referee considers a team as directly responsible of the interruption (for example forfeit). In that situation, the team which is the cause of the interruption loses the set which means the other team wins it.

The decision to stop definitively a match must be taken by the main referee.

B.11. DISQUALIFICATION

A disqualification is decided by the event director with the consent of the FAI Jury.

A disqualification affects the concerned team for the entire event. A team is disqualified is placed at the end of the ranking with a 'DISQ' mention.

Disqualification may be considered in the following situations:

- Use of a drone ball or equipment which does not conform to the rules.
- Deliberate very dangerous behavior of an active player on another person.
- Unsporting behaviour of a member of the team.

B.12. OFFICIALS

B.12.1. Event director

The event director is in charge of the complete oversight of the event.

He has the responsibility of the safety concerns and will support the main referee to ensure compliance of the event with rules.

He is also in charge to:

- Organize the running of the event (draws, detailed schedule, order of the matches, etc.) according to the event format which has been retained.
- Nominate for each match the referee (and assistants where appropriate).
- Validate the result of each match and the provisional and final ranking.

Following responsibilities and duties of the event director are also defined in the present rules:

- Definition of the eventual restrictions for use of RC systems equipment outside the playing field (see B.1.4).
- Possibility of practice flights (see B.6).

- Disqualification of a team (see B.11).

B.12.2. Referees

A main referee will be appointed for the event in order to manage sportive organization of the event in conjunction with the event director.

In addition, match referees or assistant referees may also be appointed as necessary. In the situation where match referees are not appointed, the main referee will also have the function of match referee.

B.12.2.1 Main referee

The main referee has the final authority regarding application of the drone soccer rules for the event.

Responsibilities and duties of the main referee as defined in the present rules are:

- Before the beginning of the event, definition how to proceed when it is necessary to decide between the two teams in case the match is a draw (see B.8.6).
- Checking of the compliance of the drone balls with specification rules (see B.1).

Note: *Before the event, a processing with marking of the drone balls may be organised. During the event, in case of doubt, main referee may request the organiser to check the characteristics of a specific drone ball. He may also consider a random spot-check following any race to check the most important characteristics of the drone ball.*

- Decision to reduce during the event the number of authorized active players (see B.4.1).
- Interruption of the event or delay of the start if necessary (see B.10).

B.12.2.2 Match referee

The match referee has the global responsibility to lead the match seamlessly, smoothly, and fairly in cooperation with the assistant referees where appropriate.

He must also take appropriate attention about the safety concerns during the match and take care that only authorized persons are present on the playing field.

He will be positioned in order to have an overview of the entire playing field and to be seen by the active players. He will be equipped with a microphone or equivalent in order to be heard clearly by every active player on both sides of the playing field.

Responsibilities and duties of the match referee as defined in the present rules are:

- Choice of the position of the two teams on the playing field (see B.8.1).
- Check before each set that the active players for both teams are on the players' list (see B.4.2).
- Start (see B.8.2) and end (see B.8.3) of each set.
- Break time between two sets (see B.8).
- Validation of goals and scores (see B.8.4).
- Request an active flyer to stop to fly if it is considered the drone ball no longer meets acceptable safety standards (see B.8.5).
- Set and match result (see B.8.6).
- Granting of penalties (see B.9).
- Interruption of a set for an external disturbance or any other justified reason (see B.10).
- Record at the end of the match of the score of each set, the final result of the match, the penalties which have been granted during the match and any incident he will consider justified to notice.

The main referee may change his(her) decision if he considers he has done an error of judgment or after considering the advice of an assistant referee. In any case, the position of the main referee prevails in case an assistant referee has a different opinion.

B.12.2.3 Assistant referee

When assistant referees are considered, it is recommended to appoint two assistant referees for a match (one on each side of the playing field).

Each of them will be positioned outside the flying zone in a correct place to observe their goal ring and pilots' area. They must in situation to easily communicate with the main referee.

They will be in charge to particularly follow the game on their side of the playing field.

The main referee will precise before the match to the assistant referees what he expects first and foremost from them.

B.12.3. FAI Jury

In any FAI Open International event, a FAI Jury must be nominated according to Volume CIAM General Rules C.7.1 and C.7.3.

C. F9U (PROVISIONAL CLASS) - RC MULTI-ROTOR DRONE RACING RULES

Multi-rotor Drone Racing consists of several multi-rotor model aircraft flying together through a closed racing circuit.

Note: A multi-rotor is a rotary wing radio-controlled model aircraft equipped with at least three power driven propeller devices.

The generic term 'model' will be used in the present document.

Each model is operated by an FPV (First Person View) pilot who is considered as the competitor. The FPV pilot is equipped with a headset goggle that allows him(her) to pilot from the video picture of the onboard camera which is transmitted in real time on his(her) headset goggle.

The FPV pilot is assisted during the race by one and only one helper who stays next to him during the whole flight. The helper is mandatory. He may be another competitor.

The main task of the helper is to keep the model in visual line of sight. He must inform the FPV pilot of anything occurring that can affect his(her) piloting, especially about safety. If the helper requests the FPV pilot to land or to cut off the motors, he must do it immediately. In case of emergency, the helper is authorized to shut off the transmitter in order to trigger the fail-safe device.

C.1. GENERAL SPECIFICATIONS FOR MODELS

A 1 % tolerance is applicable for inaccuracy of the measurement devices for size, weight and battery voltage.

The model must be equipped with a fail-safe device, the triggering of which stops the motors.

The following are strictly forbidden:

- Pre-programmed manoeuvring device.
- System for automatic positioning and/or path rectification in longitude, latitude or height.

Note: Software recovery modes such as 'anti Turtle' or 'anti crash' and automatic system or which can be activated by the pilot in order to level back the model after a crash are permitted.

C.1.1. Weight and size

The total weight of the model including all equipment necessary for flight (including batteries) shall not exceed 1 kg.

The axes of all motors must fit within a circle of 330 mm diameter.

C.1.2. Motorization

Only electric motors are allowed.

The maximum voltage of the flight battery must not exceed 25.5 volts (6S). The voltage measurement will be done before the flight.

Note: It will be considered in addition the opportunity to specify a maximum amount of energy ($X \text{ watt} \cdot \text{min}$) which may be used for the race. In that situation, the energy consumed must be controlled by an electronic device which stops the motors for a defined period (for example 10 seconds) in case of overrun of the maximum amount of energy authorized. Another possibility is to store in a logger the amount of energy consumed for the race and to penalize an over consumption of energy.

The reference plane is defined with propellers centres. Each motor can be tilted up to 15° maximum angle in each direction.

On a tri-copter, the inclination of a motor in flight is only allowed with the yaw order.

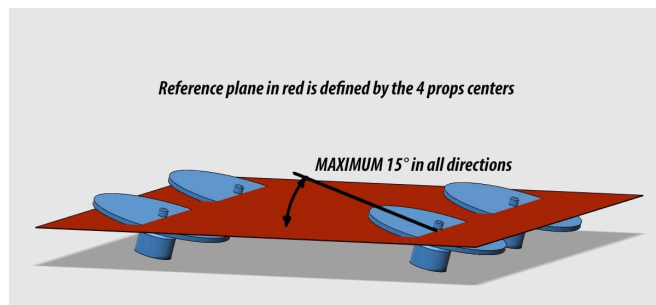

C.1.3. Propellers

Maximum diameter: 6 inches (15.2 cm).

Full metal propellers are forbidden.

Any propeller protection device is forbidden.

C.1.4. Radio control (RC) equipment

Any 2.4 GHz spread spectrum technology RC equipment may be used.

Frequencies and emission power can only be those authorized in the organizer country.

The organizer may authorize the use of other RC equipment, for example 868 MHz and/or 915 MHz TBS Crossfire module. He may also define a list of authorised equipment in order to minimize risk of radio control problems. This information must be available at least one month before the event.

In order to limit risk of potential problems during the races with unwanted interference, the organizer may define restrictions for use of RC systems equipment outside the racing circuit.

In case of use of non-authorized RC equipment, penalty going up to disqualification from the event may be imposed to the concerned competitor by the event director, with the consent of the FAI Jury (see Volume CIAM General Rules paragraph C.19.1).

C.1.5. Video system

The organizer must inform before the event about the video system that will be used for races.

A digital video recorder (DVR) is strongly recommended in order to permit to review races as necessary in case of doubt or complaint.

The organizer may define a list of authorized video transmitters (VTX) in order to minimize risk of video problems and/or permit live transmission of the pilot view on large screens for the spectators and/or media production with the appropriate quality.

The list of authorized VTX must be available at least one month before the event.

Note: *The organizer may not restrict to only one VTX. The list must not be defined with commercial consideration.*

The VTX must be set with 25 mW maximum power emission.

The organizer may also request use of a certain type of VTX antennas with the appropriate polarization.

Frequencies and emission power can only be those authorized in the organizer country.

In order to limit risk of potential problems during the races with unwanted emission, the organizer may define restrictions for use of video transmitters outside the racing circuit.

In case of non-authorized activation of a video transmitter, a penalty going up to disqualification from the event may be imposed to the concerned competitor by the event director, with the consent of the FAI Jury (see Volume CIAM General Rules paragraph C.19.1).

C.1.6. LED light device (Optional)

In order to increase visibility of the models to spectators during the races and to facilitate the task of the judges, the organizer may request that competitors equip their models with an LED light device that has the capability to choose from a set of different colours so that each model in flight can be uniquely identified.

In that situation, the organizer must define the specifications of the LED light device or a list of authorized devices at least one month before the event.

Recommended specifications:

- 40 LEDs minimum for a quadcopter (32 LEDs minimum for a tri-copter) distributed evenly so that the aircraft can be seen clearly from any direction. Recommended layout: 4 on bottom and 4 on top of each arm of the model + 8 on the sides of the body.
- Colours: Blue - Green - Orange - Pink - Purple - Red - Yellow
- RGB controller to program the assigned colour before each race.

Note: *In case an LED light unit is requested, the colour and the video frequency may be assigned for each race according to the draw order in the group. This will simplify the organisation and improve the understanding of the races by spectators.*

C.1.7. Identification mark

Each model shall carry in a clearly visible the 3 (three) letters national identification mark followed by the FAI Sporting Licence ID number.

The letters and numbers must be at least 6 mm high and appear at least once on each model.

C.2. RACING CIRCUIT

The racing circuit may be outdoor or indoor.

A racing circuit (or track) is a volume that defines a 3D flight path. It is formed by a start line, obstacles to be crossed or avoided and a finish line.

The racing circuit can be a closed loop where several laps must be completed or an open loop to be flown once. In both cases, the track can be divided into sectors to facilitate timekeeping.

The minimum length of a racing circuit from the start line to the end line, including all laps, is 250 m. The length of a track is measured along the centerline of the optimum 3D flight path.

The organizer may keep the circuit secret or make it public before the event. In both cases, the organizer must make every effort to prevent giving an unfair advantage to some competitors.

If the circuit is made public, it must be published at least one month before the event. Only minor changes are allowed following publication and those changes must be justified. The organizer must inform the competitors immediately after any changes are approved.

If the circuit is kept secret, the main characteristics (approximate length, number of laps, focused on speed/technical/both, types of obstacles, etc.) must be published at least one month before the event to allow time for the competitors to adapt their equipment as much as possible for the event.

See Annex 1 for the racing circuit specifications and recommendations.

C.3. NUMBER OF MODELS

Each competitor may use a maximum of 3 (three) models for the entire event.

A model can be used by only one competitor per event.

In case of an infringement to that rule, all concerned competitors will be disqualified from the event by the event director.

The competitor can change the model:

- before the start of the race as long as the competitor hasn't left the preparation area,
- or between two rounds of the qualification stage and elimination stage.

C.4. MODEL REGISTRATION AND PROCESSING

Each competitor can register up to three models. The organizer will mark each registered model with an easily visible, difficult to falsify identification such as a sticker.

During registration, the specifications of the model may be checked by the organizer. It is then recommended to check the following points:

- Identification mark.
- Weight and size.
- Batteries (voltage).
- Fail-safe and associated device to cut off the motors.
- Radio control equipment.
- VTX, camera and headset goggle.
- LED light unit if such a device is required by the organizer.

If a model is lost or damaged after model processing, the competitor shall have the right to present a further model for checking up to one hour before the official starting time of the event.

During official event time, a random spot-check may be organized following any race to check the most important characteristics of a model.

A competitor whose model is not compliant may be disqualified from the event by the event director.

C.5. PRACTICE FLIGHTS

Practice flights on the racing circuit other than those authorized by the organizer are strictly forbidden under threat of being disqualified from the event by the event director.

A practice session will be organized at the beginning of the event. Each competitor will only enter this practice session when he/she has finished model's registration and processing.

The organizer defines the conditions of the practice session. This information must be available at least one month before the event.

It can be a free practice session organized by groups with an allocated time identical for each group. The allocated time and the number of competitors per group will be defined by the organizer.

The practice session can also be organized together with the first round of qualifying flights. Each group will be granted one or more practice flights of 3 minutes each. The number of practice flights is defined by the organizer and must be the same for all groups. After its last practice flight, the group will stay on the circuit for its first qualifying flight; a three-minute break to change the battery pack of the model or to change the model is given before the start of the qualifying flight.

In any case, each competitor can do as many circuit laps as he/she wants within the allowed practice time. Once the practice time is over, competitors still in flight can complete their ongoing circuit lap before landing.

In case of a crash, and when the model cannot go on, the model must stay on the ground with motors cut off until the end of the practice session. The competitor cannot request another practice time except if the reason for the crash cannot be attributed to him.

C.6. EVENT ORGANISATION

An event is normally organized on the basis of three stages:

- Qualification stage (rounds for qualification for the elimination stage).
- Elimination stage (to qualify for the final stage by successive elimination rounds).
- Final stage.

Note: *When the total number of competitors is low (especially below 16), the event may be organized in one stage with a fixed number of rounds for every competitor rather than the three stages (qualification, elimination and final). In that situation, it is recommended to apply rules as defined in C.6.6 (Additional rounds sequence).*

Each round for the qualification stage and the elimination stage is organized by groups (subdivision of the round corresponding to the number of pilots flying at the same time in the same race).

It is recommended to run the event with a maximum of 4 (four) pilots per race. Nevertheless, the qualifying rounds and/or the optional additional rounds may be run with 6 (six) pilots per group subject it is legally and technically possible and if the number of competitors justify.

C.6.1. Timekeeping

Wherever possible, timekeeping will be done with an electronic timing system with appropriate redundancy in order to ensure complete and permanent reliability of the timekeeping.

Note: *In case timekeeping will be done without electronic timing system (manual timekeeping only), the organizer must inform the competitors at least one month before the event.*

Except for qualifying stage (see paragraph C.6.3), timekeeping is triggered at the start of the race.

C.6.2. Procedure for the start of the race

The start of the race will be done as follows:

- After the models have been placed on the start area, the starter will request the pilots if they are ready to start.
- When the starter considers that the pilots are ready, the starter will announce clearly 'Arm your quads'.
- About 3 seconds after this announcement and taking care of an equivalent time for all races, there will be a brief and intelligible sound signal for the start of the race; no countdown (3, 2, 1) will be done before the start signal.

The starter must immediately stop the race and do a new start when he considers that:

- the start procedure has not been done properly;

- or a pilot has jumped the start and a decision is justified to disqualify him(her).

Before the restart, the pilots will be given the opportunity to change the battery pack on their model.

C.6.3. Qualification stage

The number of qualifying rounds is defined by the organizer according to the available time with, whenever possible, a minimum of 3 (three) qualifying rounds.

Composition and flight order of the groups will be determined with a blind draw. The draw will be different for each qualifying round.

Races with fewer than the required number of pilots (4 or 6), for example in case of withdrawal of a pilot, will be put at the end of the draw of the round, in order to allow a complete pilots race with pilot(s) that have been granted a reflight in that qualifying round.

If necessary, the last groups of each qualifying round may be rearranged by the event director (under supervision of a FAI Jury member) in order to achieve as much as possible a minimum of 3 pilots per group.

Timekeeping is triggered for each model when the model passes the timekeeping sensor. In that case, each pilot must go directly after the start where the timekeeping sensor is positioned without possibility to do flight recognition of the track.

The organizer defines the qualification method which will be used and must announce it at least one month before the event.

Find below two examples of qualification methods.

a) Fastest time to complete a required number of laps

The organizer defines the number of circuit laps to complete and the time allowed for that.

For each competitor, the result of the qualification round corresponds to his(her) registered time to complete the required number of laps.

A provisional ranking will be established at the end of the qualifying stage, taking in account the best result obtained by each competitor on their qualifying flights. In case of a tie for the last place(s) for selection to the elimination round, the 2nd best result will be considered to split the tie, and then if necessary the 3rd result. In case the results of the qualifying flights are not sufficient, a tie-break flight will be organized between the competitors still concerned by the tie.

When the number of competitors required for the elimination stage is not reached, an additional qualifying flight will be organized for the competitors who have not been able to set a time at that stage. This will be repeated until the appropriate number of competitors for the elimination stage is reached.

b) Average of the 3 best times to perform a lap

The organizer defines the number of consecutive laps that will be timed and the time allowed for that.

When the pilot has finished those consecutive laps, he(she) must land the model.

The result of each competitor for the qualification stage will be the average of the 3 (three) best times recorded to perform one valid circuit lap taking in account all the qualifying rounds. Those best times may be done in the same qualifying round or in different ones.

Note: *Instead of 3, a different number of best times may be considered (2, 4, ...).*

A provisional ranking will be established at the end of the qualifying stage, taking in account the result obtained by each competitor. In case of a tie for the last place(s) for selection to the elimination stage, the 4th best time recorded to perform one valid circuit lap result will be considered to split the tie, and then if necessary the 5th one, and so on. In case the times are not sufficient, a tie-break flight will be organized between the competitors still concerned by the tie.

When the number of competitors required for the elimination stage is not reached with the competitors getting 3 (three) times, competitors getting only 2 (two) times to perform one valid circuit lap will be considered taking in account the average of their 2 times. If it is still not sufficient, competitors getting only 1 (one) time to perform one valid circuit lap will be considered.

When the number of competitors required for the elimination stage is still finally not reached, an additional qualifying flight will be organized for the competitors who have not been able to set a time at that stage. This will be repeated until the appropriate number of competitors for the elimination stage is reached.

In any case, the competitors who need an additional qualifying flight to achieve a time to be selected for the elimination stage will be placed after those who are already selected, and then those who need a second additional flight, and so on.

C.6.4. Elimination stage

The elimination stage will be organized according to one of the three following scenarios:

- Scenario A - 64 competitors selected from qualification stage.
- Scenario B - 32 competitors selected from qualification stage.
- Scenario C - 16 competitors selected from qualification stage.

The choice of scenario will be done by the organizer before the beginning of the event considering the total number of competitors in order to give possibility to a maximum of competitors to fly the elimination stage.

All races of the elimination stage will be run on a defined number of laps taking in account the performance achieved during the qualification stage. Except under exceptional circumstances, the number of laps will be identical for all rounds of the elimination stage.

The placing for each race is determined taking in account the time achieved when the number of laps is completed.

Those who will not finish their flight will be ranked considering the distance completed (number of laps and part of the last lap completed), disqualified competitors being placed at the end.

The two best placed will be directly selected for the next round. In case of a tie for the second place, the placing in the provisional ranking established at the end of the qualifying stage will be considered to define who is selected for the next round.

Double elimination optional sequence

Instead of direct elimination of the competitors placed third and fourth in each race of any elimination round, the double elimination sequence may be applied.

This sequence is optional. The organizer must inform the competitors at least one month before the event if double elimination sequence will be applied or not.

This optional sequence allows competitors eliminated in elimination rounds to continue to fly still getting possibility to access the final.

Competitors placed third and fourth in any race of the double elimination sequence are definitively eliminated.

Organisation of the races

For the first elimination round, the composition of the groups for the races is defined considering the provisional ranking established at the end of the qualifying stage.

For each scenario, the composition of races for the first elimination round and detailed organisation of the rounds up to the final are defined in an annex:

- Annex 2 for scenario A (64 competitors selected from qualification stage).
- Annex 3 for scenario B (32 competitors selected from qualification stage).
- Annex 4 for scenario C (16 competitors selected from qualification stage).

C.6.5. Final stage

In any final race, those who will not finish their flight will be ranked considering the distance completed (number of laps and part of the last lap completed), disqualified competitors being placed at the end.

The two best placed competitors in each of the two semi-finals flights are selected for the final to determine their final ranking from 1st to 4th place. The other competitors from the semi-final round will fly a small final to determine their final ranking from 5th to 8th place.

Adaptation of the final stage when double elimination sequence has been applied for the elimination stage

a) Standard way to proceed

The two best placed in the last elimination round (one race) and the two best placed in the last round of the double elimination sequence (one race) are selected for the final to determine their final ranking from 1st to 4th place.

b) Optional way to proceed

When double elimination sequence is applied, two competitors (A and B) are in the final without any losses, but the two other competitors (C and D) come from the double elimination bracket and so already have one loss each.

In order to avoid a competitor with one loss placing ahead of a competitor without any losses, the final stage may be organized in successive final races instead a single final race.

In each successive final race, pilots placed in first and second places are directly selected for the next final race. Pilots placed third and fourth (or the pilot placed third when the race concerns only 3 pilots) get one loss.

As soon as a competitor gets two losses, he is then definitively eliminated and so does not fly in the next final race. In that situation, the winner (and also possibly the second placed pilot) got one loss maximum, all other pilots being eliminated with two losses.

Note: When two pilots are eliminated in the same final race, the final placing of those two pilots will be determined considering their place in the considered race.

In case the organizer intends to apply double elimination sequence for the elimination stage, he must then inform the competitors at least one month before the event if the final stage will be run with only one final race or with successive final races. If the organizer announces nothing before the event then the final stage will be run with only one final race.

C.6.6. Additional rounds optional sequence

This sequence is optional. The organizer must inform the competitors at least one month before the event if additional rounds sequence will be applied or not.

This option allows the competitors who are not selected to fly in the first elimination round after the qualification stage to be entitled to participate to additional rounds to determine their final placing.

The number of additional rounds is defined by the organizer considering available time.

Composition and flight order of the groups will be determined with a blind draw. The draw will be different for each additional round.

Races with fewer than the required number of pilots (4 or 6), for example in case of withdrawal of a pilot, will be put at the end of the draw of the round in question, in order to allow a complete pilots race with pilot(s) that have been granted a reflight in that round.

If necessary, the last groups of each qualifying round may be rearranged by the event director (under supervision of a FAI Jury member) in order to get a maximum of races with the required number of pilots.

When a race does not contain the required number of pilots (4 or 6) at the end of the round, volunteers will be requested to allow the remaining race to start with the required number of pilots.

If there are too many volunteers, the event director (under supervision of a FAI Jury member) will conduct a blind draw to determine the necessary volunteers and then a separate draw for the order in each group (for positioning on the start line).

If there are insufficient volunteers, the race will start with fewer than the required number of pilots number (4 or 6).

The volunteer(s) shall not be eligible to have their result registered or to be granted a reflight from this race.

At the end of each race, each pilot is awarded as follows a number of points corresponding to his(her) place:

- a) **Pilots number per group = 4:** 1 point for the first placed, 2 points for the second, 3 points for the third and 4 points for the fourth. A pilot who does not fly in a race or does not finish it gets 5 points. A pilot who is disqualified for the race gets 6 points.
- b) **Pilots number per group = 6:** 1 point for the first placed, 2 points for the second, 3 points for the third, and so on. A pilot who does not fly in a race or does not finish it gets 7 points. A pilot who is disqualified for the race gets 8 points.

The final placing will be done taking in account the sum of the points awarded to every competitor in all the additional rounds. The competitor with the lower number of points is placed ahead, and so on.

In case of a tie, the placing in the provisional ranking established at the end of the qualifying stage will be considered to split the tie for the concerned competitors.

C.6.7. Final classification

Final classification tables are provided in Annex 2 for scenario A, Annex 3 for scenario B and Annex 4 for scenario C.

Those tables cover the different possible situation with double elimination and/or additional rounds sequences applied or not.

C.7. FLIGHT OCCURRENCES

C.7.1. Obstacle damaged or destroyed during the race

When an obstacle is accidentally damaged or destroyed during a race, the pilots will be informed as soon as possible of the incident and how to proceed.

Note: *The organizer must define the person (event director, starter,...) in charge to decide how to proceed and to clearly inform the pilots.*

In the case where it concerns an obstacle to be crossed (air gate, tunnel,...), the decision may be to continue to cross the obstacle, or to give permission to bypass it, or to stop the race. When bypassing of the concerned obstacle is authorized, pilots must do their best not to take advantage of the situation.

In case it concerns an obstacle to be avoided, the race will continue except if it is decided differently considering for example that safety is impacted. When race continues, pilots must do their best to follow the track and not to take advantage of the situation.

C.7.2. Faults and penalties

In the case an obstacle that needs to be crossed is not effectively crossed, the pilot may try to execute a manoeuvre to cross the obstacle again. If during this manoeuvre the pilot has a collision with another model, the pilot will be disqualified for the race. If the pilot does not cross an obstacle to be crossed, the corresponding circuit lap will not be validated by his(her) assigned judge.

In the case of a circuit cut (for example during a turn), the pilot may execute as soon as possible a manoeuvre to come back into the circuit where he left it. If his(her) assigned judge considers that the pilot has not made the manoeuvre with sufficient urgency, the judge can decide that the corresponding circuit lap is not validated. If during this manoeuvre the pilot has a collision with another model, the pilot will be disqualified for the race.

In both cases, the pilot whose model has been collided into may be granted a reflight if he(her) is considered no longer able to continue his(her) flight in a competitive way. In that situation, the pilot must stop his(her) flight as soon as possible after the collision and say it clearly. The reflight will be granted subject to the corresponding judge confirming that the collision has clearly penalised the pilot. If the pilot decides to continue to fly, a reflight may not be considered.

C.7.3. Disqualification from the race

A pilot may also be disqualified from a race in the following scenarios:

- a start before the start signal if it is considered that this early start gives a clear advantage to the concerned pilot;
- a circuit exit (crossing of the safety line);
- a celebratory manoeuvre, especially after the pilot finishes.

The disqualification is decided at the discretion of the judge assigned to the concerned pilot.

The judge can also pronounce a disqualification if the judge considers that:

- the pilot flies so high that the performance of the pilot on the track cannot be judged;
- the piloting is hazardous or if safety is compromised.

When a pilot is disqualified, he must land as soon as he has been informed. In any case, the result of the pilot for the race will not be validated. If the pilot is considered not being sufficiently cooperative to land, the concerned pilot may be disqualified from the event by the FAI Jury on request of the assigned judge.

C.7.4. Crash

When a model crashes, the concerned pilot can resume if the model is in a situation to do so.

When the model cannot go on, it must stay on the ground with motors cut off until the end of the race. The pilot must clearly say that he has stopped flying.

C.7.5. Safety occurrence

The pilot can be requested to stop the flight if it is considered the model no longer meets acceptable safety standards. It could be for example the case when a model is damaged after a collision or after a crash, or when the battery is dangling.

In such a situation, a reflight for the concerned pilot may not be considered.

C.8. REFLIGHTS

C.8.1. Causes for reflight

Incidents during races such as a collision with an obstacle or a collision between models cannot justify a reflight, except in the specific situation defined in sub-paragraph C.7.2.

When a pilot gets a video problem that he/she considers will prevent him/her from continuing the flight, he/she must immediately say it clearly. A reflight will only be considered if the pilot has used the video from the organizer's receiver and if the problem is confirmed by the judge.

In addition, a reflight may be considered when:

- Either the model cannot start or the flight cannot be made in normal conditions because of an unexpected cause beyond the pilot's control.
- For a reason of safety, either the model cannot be prepared or the flight cannot be made in the allotted time limit or when either is disrupted by an external interference.
- For a reason independent from the pilot's will, the pilot has been forced to land by request of an official. Failures of the model, motorization or radio cannot be considered as reasons independent from the pilot's will.
- The chair of the pilot clearly affects his/her flight; if the helper of the pilot is the cause of the problem then a reflight cannot be granted.

Noise in the environment of the pilots (noise in the public, noise from other competitors,...) cannot justify a reflight.

For any pilot being granted a reflight, the original flight for which the pilot has been granted the reflight is then definitively cancelled.

C.8.2. Organization of the reflights

Reflights for individuals are permitted for the qualifying stage and, as such, reflights may be organised separately or as part of any races that have fewer than the required number of pilots.

The same applies for the additional rounds optional sequence if done according to the modalities defined for this sequence in sub-paragraph C.6.6.

Elimination and final stages

It is not possible to organize an individual reflight for elimination stage because the placing in the race determines the selection for the next round so the race must be restarted when a reflight is granted.

The same applies for the final stage.

It is desirable to stop the race as soon as possible once an incident occurs that may justify a reflight. The restart will only concern the pilot who has been granted a reflight and the pilots who were still in the air when the stop of the race has been announced.

Note: *The organizer must define the person (event director, starter, ...) in charge to decide the stop of the race and to inform clearly the pilots.*

In the case where the race has not been stopped and that subsequently a reflight is granted, a new race will be organized. This new race will include only the pilot who has been granted a reflight and the pilots who have finished the original race (or placed first or second at the end of the original race for those who don't finish it). Instead of participating in the new race, a pilot may choose to keep the time he got in the original race; in that situation, his/her placing will be considered by comparing his/her time in the original race against the new times of the pilots who participate in the new race.

C.9. OFFICIALS

C.9.1. Officials needed to run the event

The running of an event requires the main following officials:

- Event director in charge of preparation, organisation and oversight of the event. The event director has responsibility to ensure compliance with the applicable rules and safety during the whole event.

- Starter. The starter may be assisted by another official in charge to call pilots for racing, do pre-flight checking, etc.
- Judges (one per pilot) in charge to check all aspects of the pilot's racing on the circuit and to complete the score sheet after the race.

Note: *It is acceptable to consider for judging the pilots of the next race instead dedicated judges. In that situation, the organizer must inform the competitors at least one month before the event.*

- Official responsible for score sheets gathering and/or for results accounting.

Note: *If timekeeping is done manually (not recommended), one timekeeper minimum per pilot is necessary.*

According to the event standing and the number of competitors, some official tasks may be assumed by the same person.

C.9.2. FAI Jury

In any FAI Open International event, a FAI Jury must be nominated according to Volume CIAM General Rules C.7.1 and C.7.3.

C.9.3. Judges

In each race, each FPV pilot will be scored by a judge.

The judge will have a video device (video screen, headset or goggles) allowing them to follow the flight of his(her) assigned pilot, sharing the same picture as the pilot.

The judge will monitor that the pilot follows the circuit and crosses every gate and obstacle correctly.

If the judge is placed adjacent to his(her) assigned pilot (which is not mandatory), he may optionally notify the competitor at the moment of any infringement but is not required to do so for a lap not validated.

Note: *When judges are not placed adjacent to the pilots, the organizer must define the person who must inform a pilot when he(she) is disqualified or must the flight considering the model no longer meets acceptable safety standards.*

The judge must be satisfied that any undertaking by the pilot to re-attempt a missed gate, obstacle or circuit cut is conducted in compliance with the rules and that any competitive advantage has been forfeit.

At the end of the flight, the pilot will be informed if the flight is considered to be valid or if a disqualification has been pronounced; in the case of disqualification, the number of circuit laps done at the moment of the disqualification will be communicated by the judge to the concerned pilot and recorded.

Note: *The organizer may also provide a dedicated line judge in charge of informing the flight judges if a model crosses the safety line (exit of the circuit).*

C.10. INTERRUPTION OF THE EVENT

The event should be interrupted or the start delayed by the event director in the following circumstances:

- Wind continuously stronger than 9 m/s measured at 2 m above the ground near the preparation area for at least one (1) minute.
- Due to atmospheric conditions (rain, stormy condition,,...) in which it would be dangerous to continue to fly.
- Other exceptional circumstances such as for example incident affecting safety or requiring access for emergency services.

When an interruption occurs during an official flight, this flight is cancelled.

If the event cannot go on, the final ranking will be the last available provisional ranking.

C.11. COMPETITORS INFORMATION

The organizer has to display on the site:

- FAI Jury composition;
- start list for every round;
- results after every round;
- provisional rankings and final placing.

Note: *A posting on Internet is also advised if conditions permit it, in order to make it possible for those who are not at the site to follow the progress of the event.*

- **ANNEX C.1** - **RACING CIRCUIT**

1. Racing circuit design

The track should be designed to maximize competition and to demonstrate piloting skills. The organizer is encouraged to demonstrate creativity and to take advantage of the specifics of the site. It is recommended to facilitate live spectator viewing by making the track understandable from an outside point of view.

All racing circuits must be designed on the “safety first” principle. The flight path must prevent accidental diversions from the racing area. In this context, if a pilot flies out of the optimal path, any trajectory to get back to the track must be made in the direction of a safe area without any persons (public, pilots, helpers, judges).

2. Safety

The area where the flight zone is allocated shall be demarcated by a “safety line”. The safety line shall surround the start line, end line, obstacles, 3D flight path, trajectories to get back to the track and areas which a model can reach in case of crash or losing of control.

The safety line must be an unmistakable physical element or marker that must not be crossed by any person without the authorization of an official. The organizer must prepare basic procedures in case of fire or first aid inside the safety line. The plans must be informed to any person before being authorized to cross the safety line

During races or if any model is flying, the presence of any person without the adequate safety equipment (nets, cages, protection suit) in the flight area is strictly forbidden.

The organizer must take care that the competition, live viewing and media coverage of the event can be done while guaranteeing the safety of the concerned persons. Areas for pilots, officials and spectators must be secured (nets, fences, transparent walls, recommended minimum separation,...) to avoid uncontrolled models reaching them.

3. Start

To avoid collisions during the start, the models shall be placed on the start line using one of two schemes:

- 1) Side by side in a single line perpendicular to the optimum starting trajectory, with a minimum separation of 0.5 m and a maximum separation of 1 m between models.
- 2) An inverted 'V' or '_/ ' pattern with one or more models in the front. The minimum separation between models shall be 0.5 m on the side and 0.5 m on the front/back. The maximum separation shall be 1 m on the side and 1.5 m on the back.

If the track is a closed circuit, the start line can be outside of the circuit track.

The model positioning during the start should benefit the pilot with the best performance during the previous stage. If two or more pilots have the same previous performance, the positioning will be decided by a draw.

4. Obstacles

The number of obstacles must be adapted to the environment characteristics; in particular, the available space. The number of obstacles shall maximize competition and demonstrate pilot skills.

Obstacles can be located at any height and position. The flight path between obstacles must allow a smooth flight.

Obstacles must contrast with the background and be perfectly visible with a standard FPV video device at a distance of 30 m. The flight path, once in the area defined by the obstacle, must be clearly marked and obvious to follow.

There are two types of obstacles:

1) Obstacles to be crossed

This type of obstacle (single air gate, combination of air gates, tunnel, etc.) can be crossed in any 3D direction. The internal space can be 2D or 3D of any length and shape. The internal space along with any area used by the optimal flight path must be free of any rigging (wire, rope, etc.).

The obstacle inside shall be free space within a minimum diameter of 1.5 m centered in the optimal flight path.

2) Obstacles to be avoided

This type of obstacle (wall, flag, pylon, flyer, etc.) defines virtual or physical areas that are not intended to cross. They can be a single obstacle to avoid shortcuts or a combination of them that create structures such as horizontal or vertical slaloms.

The design must allow a free space to avoid the obstacle. The free space shall be of a minimum 2.5 m diameter centered in the optimal 3D flight path.

Reasonable efforts should be made by organizers to create or to cover obstacles by shock absorbing materials to protect models in case of a crash.

5. Finish line

The finish line indicates the end of the race. If the track is a closed circuit, the finish line is not necessarily on the circuit track.

The finish line shall be defined by a 2D area to be crossed. The pilot finishes the race when his(her) model touches the area and crosses it completely.

There shall be a pick-up area after the finish line to land or to recover safely the models. The area shall be designed not to interfere after crossing the finish line with the flight of the other pilots.

- ANNEX C.2 -**SCENARIO A - 64 competitors selected from qualification stage****1- Composition of the races for the 1st elimination round**

Race 1	Placed 1	Placed 17	Placed 33	Placed 49
Race 2	Placed 16	Placed 32	Placed 48	Placed 64
Race 3	Placed 8	Placed 24	Placed 40	Placed 56
Race 4	Placed 14	Placed 30	Placed 46	Placed 62
Race 5	Placed 4	Placed 20	Placed 36	Placed 52
Race 6	Placed 12	Placed 28	Placed 44	Placed 60
Race 7	Placed 6	Placed 22	Placed 38	Placed 54
Race 8	Placed 10	Placed 26	Placed 42	Placed 58
Race 9	Placed 9	Placed 25	Placed 41	Placed 57
Race 10	Placed 5	Placed 21	Placed 37	Placed 53
Race 11	Placed 11	Placed 27	Placed 43	Placed 59
Race 12	Placed 3	Placed 19	Placed 35	Placed 51
Race 13	Placed 13	Placed 29	Placed 45	Placed 61
Race 14	Placed 7	Placed 23	Placed 39	Placed 55
Race 15	Placed 15	Placed 31	Placed 47	Placed 63
Race 16	Placed 2	Placed 18	Placed 34	Placed 50

2- Organisation of the rounds (without applying double elimination optional sequence)

1 st ELIMINATION ROUND	2 nd ELIMINATION ROUND	3 rd ELIMINATION ROUND	SEMI FINAL ROUND	FINALS		
Race 1	Race 17	Race 25	Semi 1	Small final		
Race 2					2 nd race 1	2 nd race 17
Race 3	1 st race 1	1 st race 17				
Race 4	1 st race 2	1 st race 18				
Race 5	2 nd race 2	2 nd race 18				
Race 6	2 nd race 3	Race 26			Semi 2	Final
Race 7	1 st race 3					
Race 8	1 st race 4	1 st race 19				
Race 9	2 nd race 4	2 nd race 20				
Race 10	2 nd race 5	Race 27	Semi 2	Final		
Race 11	1 st race 5				2 nd race 21	
Race 12	1 st race 6	1 st race 21				
Race 13	2 nd race 6	1 st race 22				
Race 14	2 nd race 7	2 nd race 22				
Race 15	1 st race 7	Race 28			Semi 2	Final
Race 16	1 st race 8					
	2 nd race 8	1 st race 23				
	2 nd race 9	1 st race 24				
	1 st race 9	2 nd race 24				
	1 st race 10					
	2 nd race 10					
	1 st race 11					
	2 nd race 11					
	1 st race 12					
	2 nd race 12					
	2 nd race 13					
	1 st race 13					
	1 st race 14					
	2 nd race 14					
	2 nd race 15					
	1 st race 15					
	1 st race 16					
	2 nd race 16					

3- Organisation of the rounds with the double elimination sequence

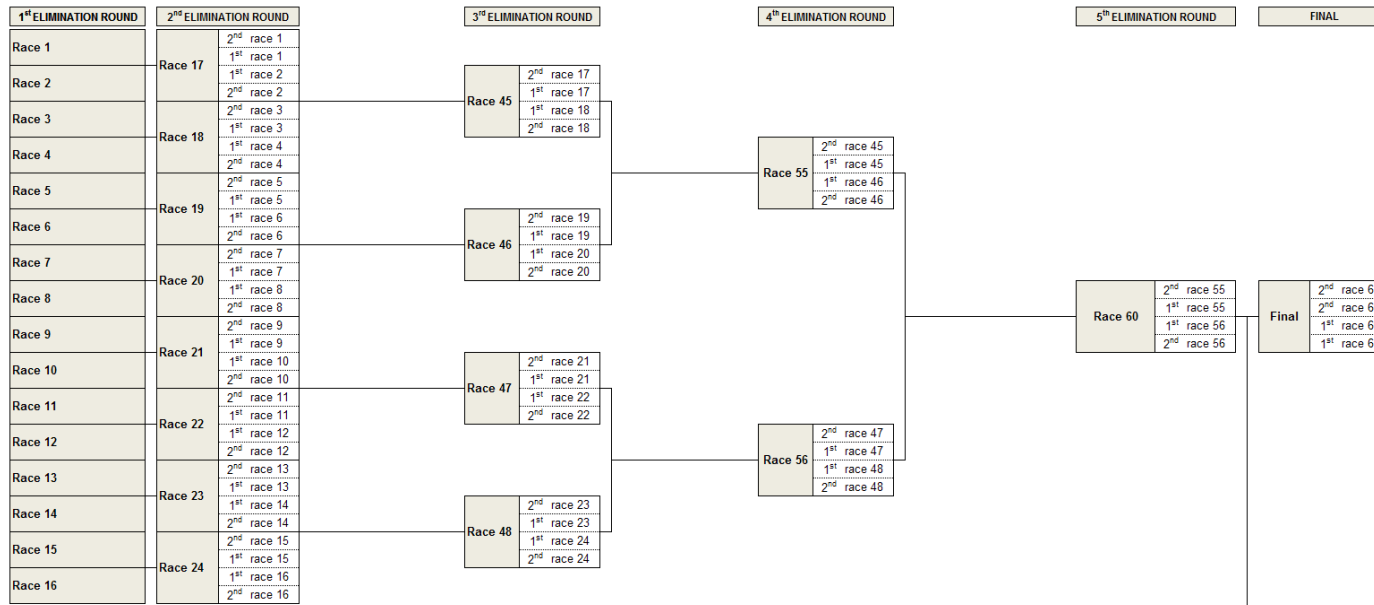

DOUBLE ELIMINATION SEQUENCE											
Race 25	4 th race 1 3 rd race 2 3 rd race 3 4 th race 4	Race 33	3 rd race 17 2 nd race 31 1 st race 32 4 th race 18	Race 41	2 nd race 35 1 st race 33 1 st race 34 2 nd race 36	Race 49	3 rd race 45 2 nd race 43 1 st race 44 4 th race 46	Race 53	2 nd race 51 1 st race 49 1 st race 50 2 nd race 52	Race 57	3 rd race 55 1 st race 53 2 nd race 54 4 th race 56
Race 26	4 th race 5 3 rd race 6 3 rd race 7 4 th race 8	Race 34	3 rd race 19 2 nd race 29 1 st race 30 4 th race 20	Race 42	2 nd race 33 1 st race 35 1 st race 36 2 nd race 34	Race 50	3 rd race 47 2 nd race 41 1 st race 42 4 th race 48	Race 54	2 nd race 51 1 st race 49 1 st race 51 2 nd race 50	Race 58	3 rd race 56 1 st race 54 2 nd race 53 4 th race 55
Race 27	4 th race 2 3 rd race 1 3 rd race 4 4 th race 3	Race 35	3 rd race 18 2 nd race 32 1 st race 31 4 th race 17	Race 43	2 nd race 39 1 st race 37 1 st race 38 2 nd race 40	Race 51	3 rd race 46 2 nd race 44 1 st race 43 4 th race 45	Race 55	2 nd race 49 1 st race 51 1 st race 52 2 nd race 50	Race 59	2 nd race 57 1 st race 57 1 st race 58 2 nd race 58
Race 28	4 th race 6 3 rd race 5 3 rd race 8 4 th race 7	Race 36	3 rd race 20 2 nd race 30 1 st race 29 4 th race 19	Race 44	2 nd race 37 1 st race 39 1 st race 40 2 nd race 38	Race 52	3 rd race 48 2 nd race 42 1 st race 41 4 th race 47	Race 61	3 rd race 60 1 st race 59 2 nd race 59 4 th race 60		
Race 29	4 th race 9 3 rd race 10 3 rd race 11 4 th race 12	Race 37	3 rd race 21 2 nd race 26 1 st race 25 4 th race 22								
Race 30	4 th race 13 3 rd race 14 3 rd race 15 4 th race 16	Race 38	3 rd race 23 2 nd race 28 1 st race 27 4 th race 24								
Race 31	4 th race 10 3 rd race 9 3 rd race 12 4 th race 11	Race 39	3 rd race 22 2 nd race 25 1 st race 26 4 th race 21								
Race 32	4 th race 14 3 rd race 13 3 rd race 16 4 th race 15	Race 40	3 rd race 24 2 nd race 27 1 st race 28 4 th race 23								

4- Final classification

Place	Without double elimination	Place	With double elimination
1	1 st in final	1	1 st in final
2	2 nd in final	2	2 nd in final
3	3 rd in final	3	3 rd in final
4	4 th in final	4	4 th in final
5	1 st in small final	5	3 rd in race 61
6	2 nd in small final	6	4 th in race 61
7	3 rd in small final	7	3 rd in race 59
8	4 th in small final	8	4 th in race 59
9 to 16	3 rd and 4 th in races 25 to 28 with final placing according to provisional ranking after qualifying stage	9 to 12	3 rd and 4 th in races 57 and 58 with final placing according to provisional ranking after qualifying stage
		13 to 16	3 rd and 4 th in races 53 and 54 with final placing according to provisional ranking after qualifying stage
17 to 32	3 rd and 4 th in races 17 to 24 with final placing according to provisional ranking after qualifying stage	17 to 24	3 rd and 4 th in races 49 to 52 with final placing according to provisional ranking after qualifying stage
		25 to 32	3 rd and 4 th in races 41 to 44 with final placing according to provisional ranking after qualifying stage
33 to 64	3 rd and 4 th in races 1 to 16 with final placing according to provisional ranking after qualifying stage	33 to 48	3 rd and 4 th in races 33 to 40 with final placing according to provisional ranking after qualifying stage
		49 to 64	3 rd and 4 th in races 25 to 32 with final placing according to provisional ranking after qualifying stage
65 and beyond	With additional rounds sequence		
	Placing according to sum of points in all additional rounds; competitor with the lower number of points is placed ahead, and so on. In case of tie, provisional ranking after qualifying stage considered to split the tie for the concerned competitors.		
Additional rounds sequence not applied			
Placing according to provisional ranking after qualifying stage.			

- ANNEX C.3 -**SCENARIO B - 32 competitors selected from qualification stage****1- Composition of the races for the 1st elimination round**

Race 1	Placed 1	Placed 9	Placed 17	Placed 25
Race 2	Placed 8	Placed 16	Placed 24	Placed 32
Race 3	Placed 6	Placed 14	Placed 22	Placed 30
Race 4	Placed 4	Placed 12	Placed 20	Placed 28
Race 5	Placed 3	Placed 11	Placed 19	Placed 27
Race 6	Placed 5	Placed 13	Placed 21	Placed 29
Race 7	Placed 7	Placed 15	Placed 23	Placed 31
Race 8	Placed 2	Placed 10	Placed 18	Placed 26

2- Organisation of the event (without double elimination)

1 st ELIMINATION ROUND	2 nd ELIMINATION ROUND		SEMI FINAL ROUND		FINALS	
Race 1	Race 9	2 nd race 1	Semi 1	2 nd race 9	Small final	4 th semi 1
Race 2		1 st race 1		1 st race 9		3 rd semi 1
Race 3	1 st race 2	2 nd race 2		1 st race 10		3 rd semi 2
Race 4	2 nd race 3	1 st race 3		2 nd race 10		4 th semi 2
Race 5	Race 10	2 nd race 4	Semi 2	Final		2 nd semi 1
Race 6		1 st race 4				2 nd race 5
Race 7	1 st race 5	1 st race 6			1 st race 11	1 st semi 2
Race 8	2 nd race 5	2 nd race 6			1 st race 12	2 nd semi 2
	Race 11	2 nd race 7				
		1 st race 7				
	Race 12	1 st race 8				
		2 nd race 8				

3- Organisation of the event with the double elimination

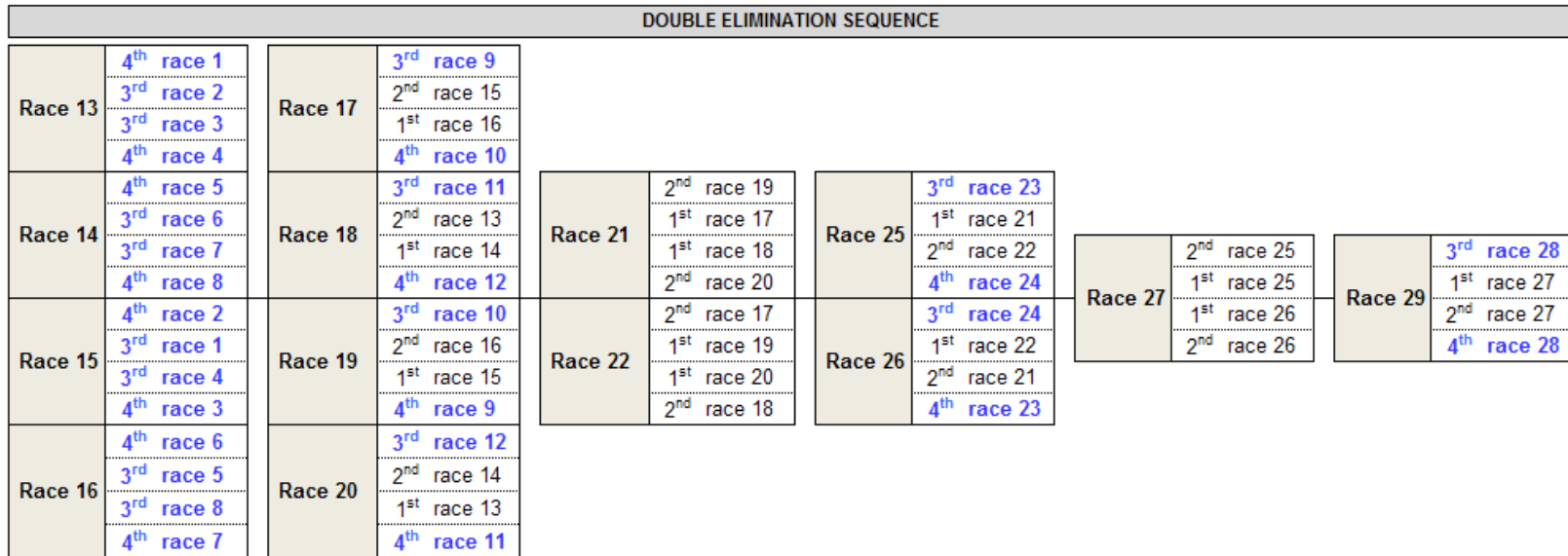
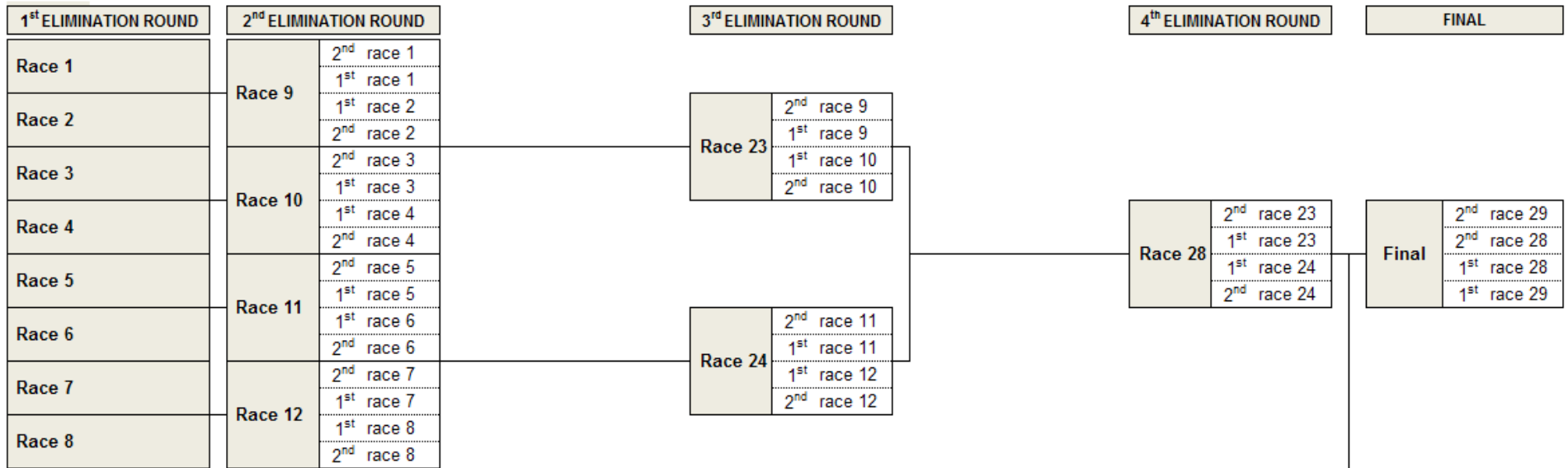

4- Final classification

Place	Second chance sequence not applied	Place	With second chance sequence
1	1 st in final	1	1 st in final
2	2 nd in final	2	2 nd in final
3	3 rd in final	3	3 rd in final
4	4 th in final	4	4 th in final
5	1 st in small final	5	3 rd in race 29
6	2 nd in small final	6	4 th in race 29
7	3 rd in small final	7	3 rd in race 27
8	4 th in small final	8	4 th in race 27
9 to 16	3 rd and 4 th in races 9 to 12 with final placing according to provisional ranking after qualifying stage	9 to 12	3 rd and 4 th in races 25 and 26 with final placing according to provisional ranking after qualifying stage
		13 to 16	3 rd and 4 th in races 21 and 22 with final placing according to provisional ranking after qualifying stage
17 to 32	3 rd and 4 th in races 1 to 8 with final placing according to provisional ranking after qualifying stage	17 to 24	3 rd and 4 th in races 17 to 20 with final placing according to provisional ranking after qualifying stage
		25 to 32	3 rd and 4 th in races 13 to 16 with final placing according to provisional ranking after qualifying stage
33 and beyond	With additional rounds sequence		
	Placing according to sum of points in all additional rounds; competitor with the lower number of points is placed ahead, and so on In case of tie, provisional ranking after qualifying stage considered to split the tie for the concerned competitors.		
Additional rounds sequence not applied			
Placing according to provisional ranking after qualifying stage.			

- ANNEX C.4 -**SCENARIO C - 16 competitors selected from qualification stage****1- Composition of the races for the 1st elimination round**

Race 1	Placed 1	Placed 5	Placed 9	Placed 13
Race 2	Placed 4	Placed 8	Placed 12	Placed 16
Race 3	Placed 3	Placed 7	Placed 11	Placed 15
Race 4	Placed 2	Placed 6	Placed 10	Placed 14

2- Organisation of the event (without double elimination)

1 st ELIMINATION ROUND	SEMI FINAL ROUND		FINALS	
Race 1	Semi 1	2 nd race 1	Small final	4 th semi 1
Race 2		1 st race 1		3 rd semi 1
Race 3		1 st race 2		3 rd semi 2
Race 4		2 nd race 2		4 th semi 2
Race 3	Semi 2	2 nd race 3	Final	2 nd semi 1
Race 4		1 st race 3		1 st semi 1
		1 st race 4		1 st semi 2
		2 nd race 4		2 nd semi 2

3- Organisation of the event with double elimination

1 st ELIMINATION ROUND		2 nd ELIMINATION ROUND		3 rd ELIMINATION ROUND		FINAL	
Race 1		Race 7	2 nd race 1	Race 12	2 nd race 7	Final	2 nd race 13
Race 2			1 st race 1				1 st race 7
Race 3		1 st race 2	2 nd race 2		1 st race 8		1 st race 12
Race 4		2 nd race 2			2 nd race 8		1 st race 13
		Race 8	2 nd race 3				
			1 st race 3				
			1 st race 4				
			2 nd race 4				
DOUBLE ELIMINATION SEQUENCE							
Race 5	4 th race 1	Race 9	4 th race 8	Race 11	2 nd race 9	Race 13	4 th race 12
	3 rd race 2		2 nd race 6		1 st race 9		2 nd race 11
	3 rd race 3		1 st race 5		1 st race 10		1 st race 11
	4 th race 4		3 rd race 7		2 nd race 10		3 rd race 12
Race 6	4 th race 2	Race 10	4 th race 7				
	3 rd race 1		2 nd race 5				
	3 rd race 4		1 st race 6				
	4 th race 3		3 rd race 8				

4- Final classification

Place	Second chance sequence not applied	Place	With second chance sequence
1	1 st in final	1	1 st in final
2	2 nd in final	2	2 nd in final
3	3 rd in final	3	3 rd in final
4	4 th in final	4	4 th in final
5	1 st in small final	5	3 rd in race 13
6	2 nd in small final	6	4 th in race 13
7	3 rd in small final	7	3 rd in race 11
8	4 th in small final	8	4 th in race 11
9 to 16	3 rd and 4 th in races 1 to 4 with final placing according to provisional ranking after qualifying stage	9 to 12	3 rd and 4 th in races 9 and 10 with final placing according to provisional ranking after qualifying stage
		13 to 16	3 rd and 4 th in races 5 and 6 with final placing according to provisional ranking after qualifying stage
17 and beyond	With additional rounds sequence		
	Placing according to sum of points in all additional rounds; competitor with the lower number of points is placed ahead, and so on In case of tie, provisional ranking after qualifying stage considered to split the tie for the concerned competitors.		
17 and beyond	Additional rounds sequence not applied		
	Placing according to provisional ranking after qualifying stage.		